

PLANE PRINT.com

very light 3d printable rc planes



ICON A5

- Detailed scale model in 3D lightweight construction.
- Real 1 wall construction (Currently only supported by CURA!).
- Wingspan 1100 mm (43.3 inches), designed for micro sized electronics.



WATCH OUT!
This 3D print model
is specially optimized
for CURA.



STL DATA FOR DOWNLOADING
AT www.planeprint.com

PRINTING THE PARTS – PRINTING PROFILES

You may wonder why this 3D model is suitable exclusively for CURA right?

The most important thing about small RC model airplanes is always the ratio of size to weight. The lighter a model is, the better its flight characteristics and also the flight time is significantly increased.

With our unique design process, we manage to make weights relevant items in a **true 1-wall printing process** for the outer skin but also for the filling offer. So we save weight while maintaining the necessary stability.

Here we show you how to get started from a standard CURA profile Make settings. For this model we only need 4, easy to create profiles.

It is **absolutely necessary** to observe the information provided by **PLANEPRINT.com** in order: to slice the component correctly. However, it may make sense to perfect your 3D printing by additionally performing several hiring activities depending on your printer and the filament used.

For slicing all Planeprint models, four profiles have to be created in Cura:

PROFILE P1_fullbody
PROFILE P2_hollowbody
PROFILE P3_surface
PROFILE P4_flex

You can find the description at www.planepprint.com/print

Important for the 1-wall-print!

In order to print airfoils of the lowest possible weight with high stability, it is necessary to print with only one wall line (Nozzle 0.4 mm). Decisive here is the adhesion between the layers! To achieve this, you must print at a much higher temperature than normal. As a **guideline**, 230 ° C is a good starting point. The parts-cooling fan should be set to 0% or a maximum of 20%. Since not every printer works the same, it may be necessary to make small adjustments to these settings.



The development of a complex, airworthy RC flight model to express on any standard 3D printer is a very complex and extensive process. Therefore, we appeal to your fairness not to forward the STL data you have acquired to third parties. Our STL files are provided with indelible copyright watermarks that can be verified at any time.

Thank you for your understanding and have fun with your PLANEPRINT MODEL!

PRINTING MANUAL

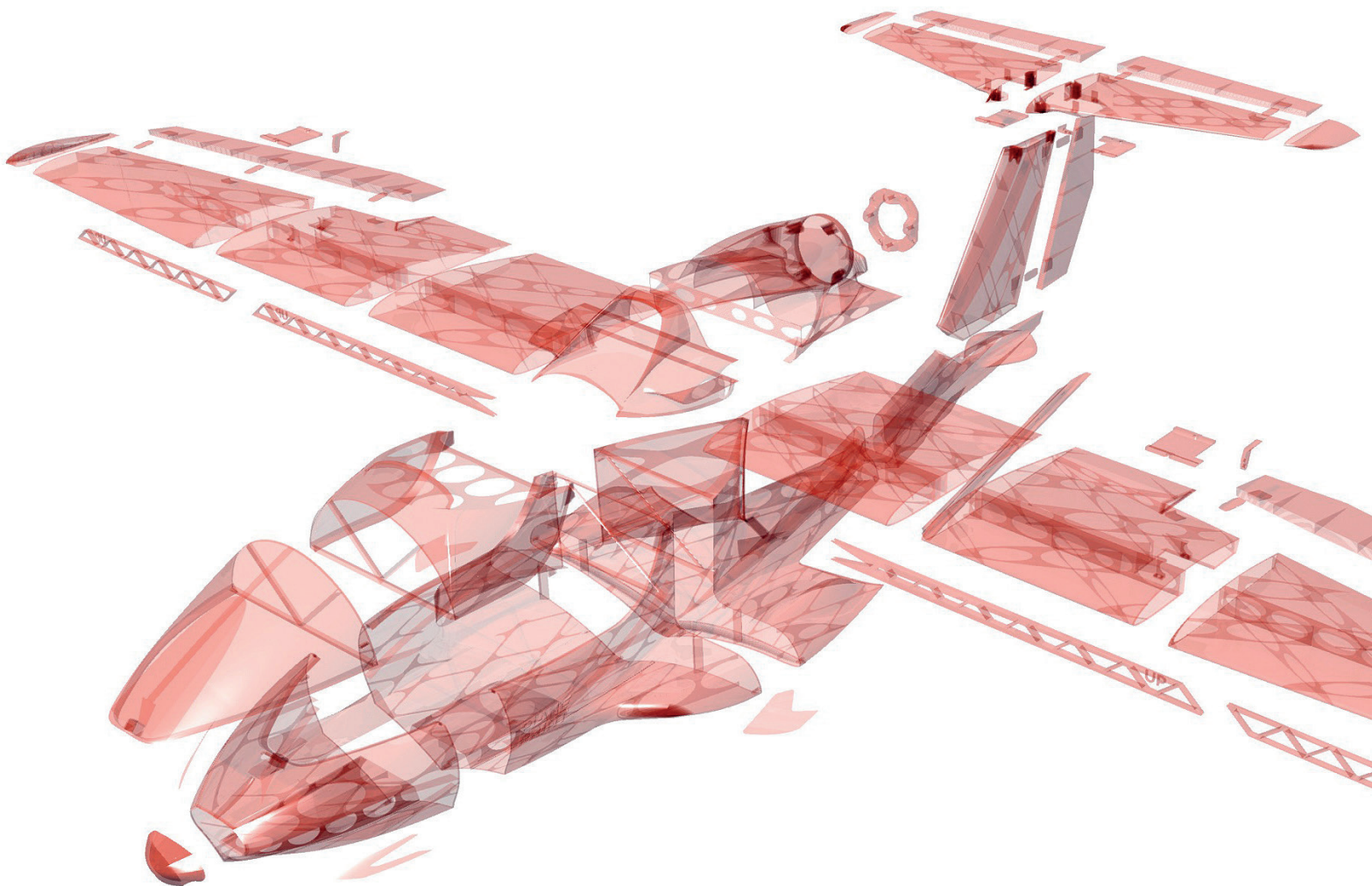

PROFILE P1_FULLBODY

The following parts must be sliced with the profile P1_FULLBODY.
Recommended additional settings are listed in the screenshots.

INFO

STL File: Engine mount-p1.stl
Material: PLA
Weight: ~ 4 g

ADDITIONAL SETTINGS

None required

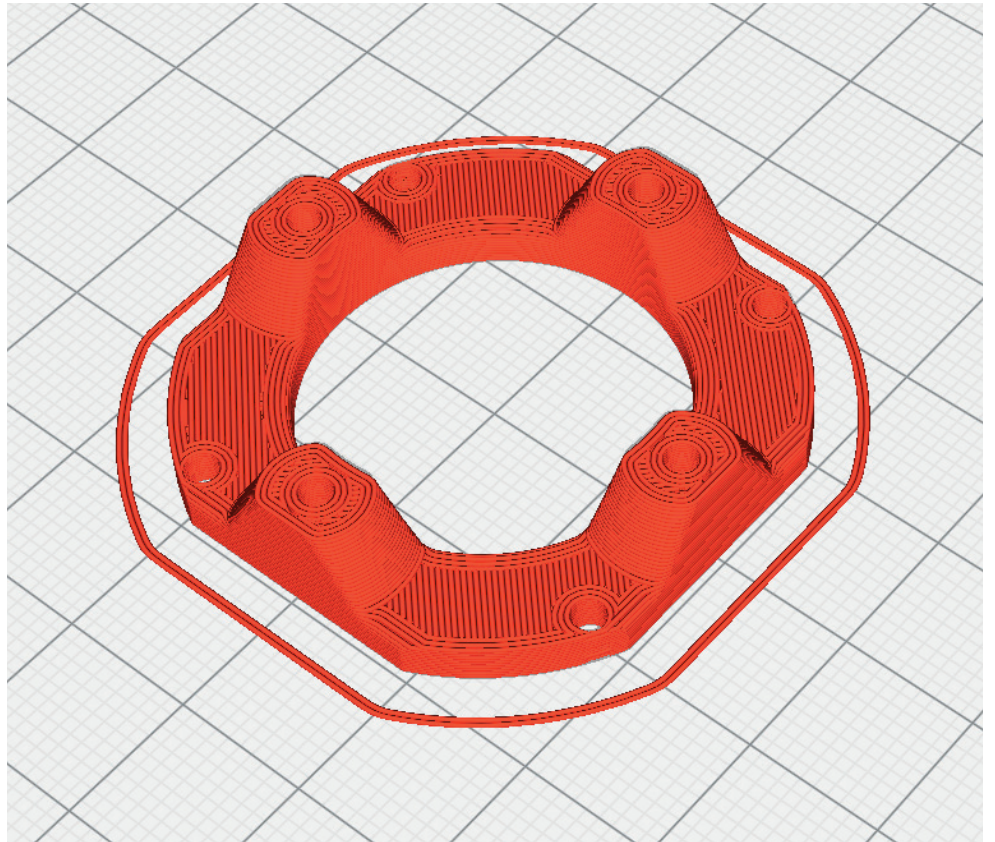

INFO

STL file: Fuselage 1-p1.stl
Material: PLA
Weight: ~ 3 g

ADDITIONAL SETTINGS

None required

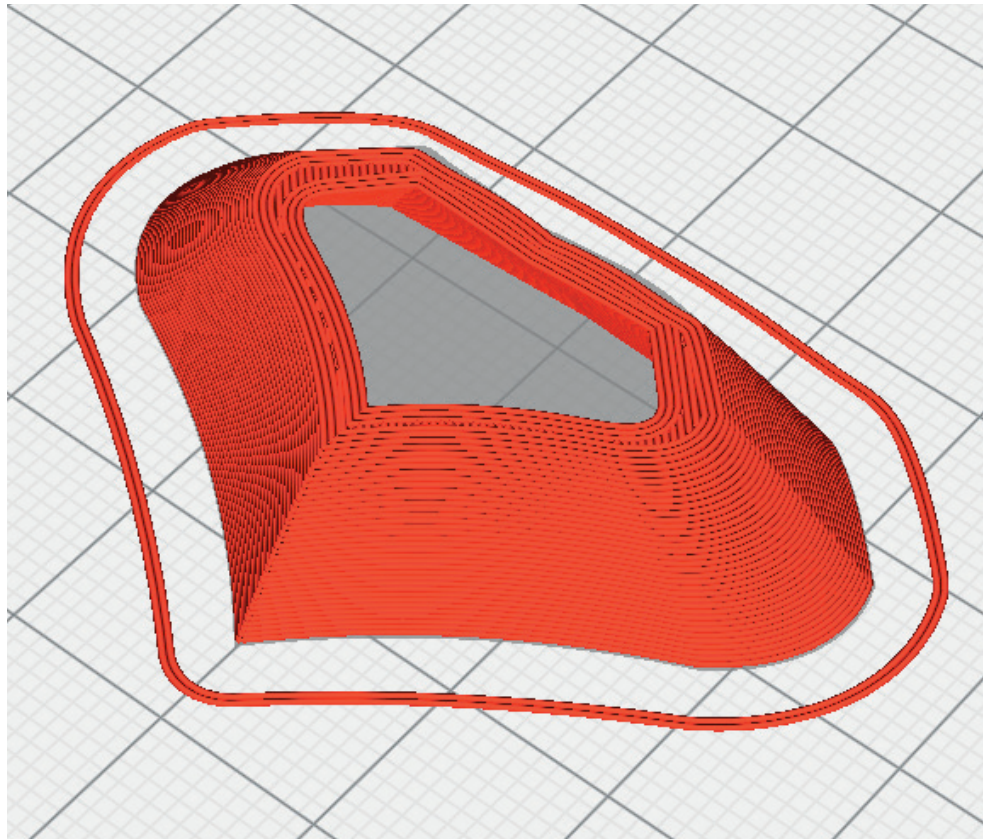

PROFIL P1_FULLBODY

INFO

STL file: Parts 1-p1.stl
Material: PLA
Weight: ~ 4 g

ADDITIONAL SETTINGS

None required

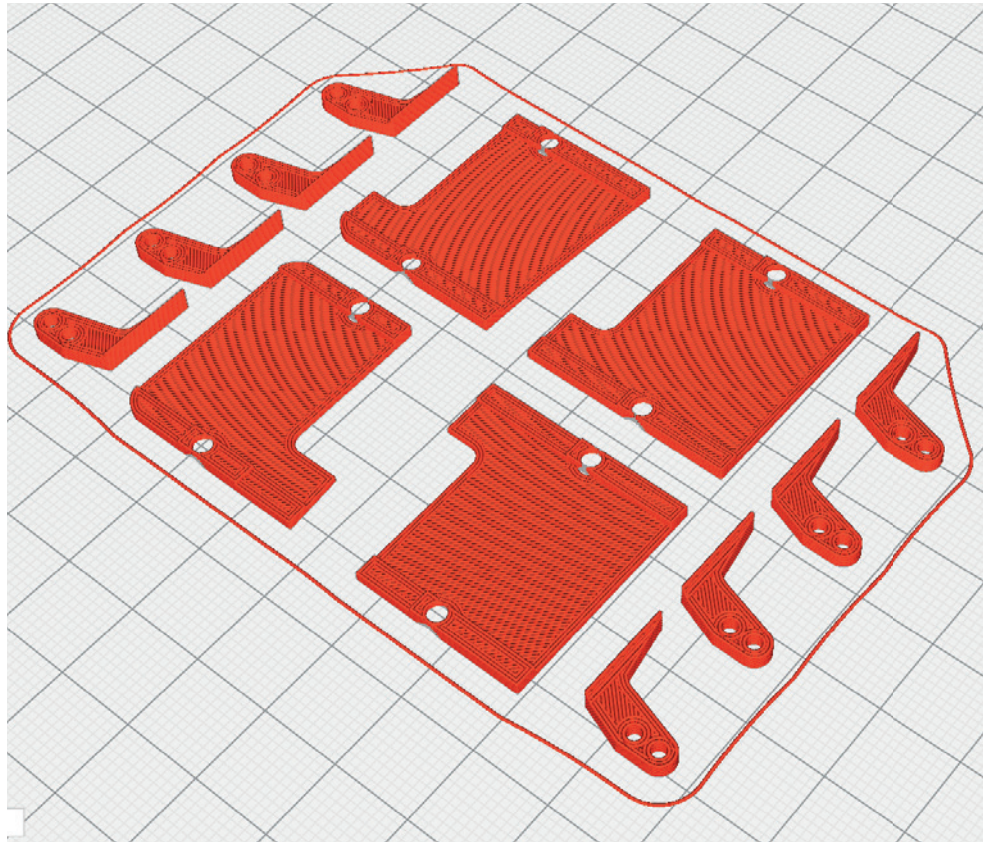

INFO

STL file: Parts 2-p1.stl
Material: PLA
Weight: ~ 1 g

ADDITIONAL SETTINGS

None required

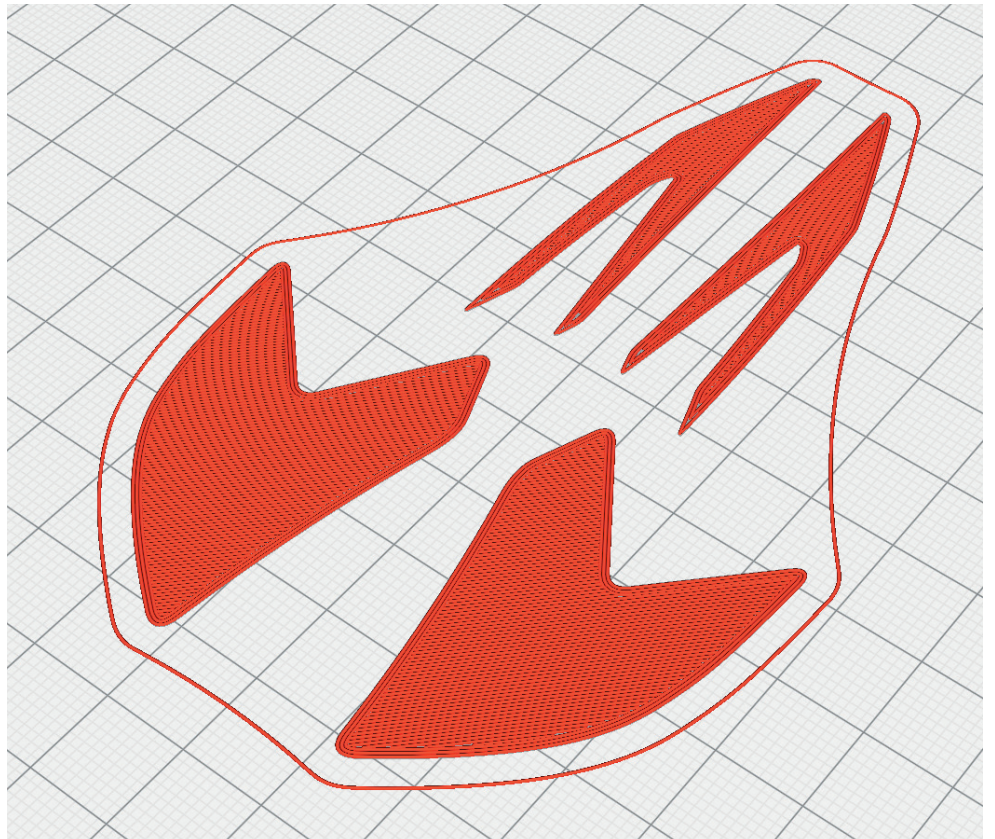

PROFILE P1_FULLBODY

INFO

STL file: Wing spar-p1.stl
Material: PLA
Weight: ~ 19 g

ADDITIONAL SETTINGS

None required

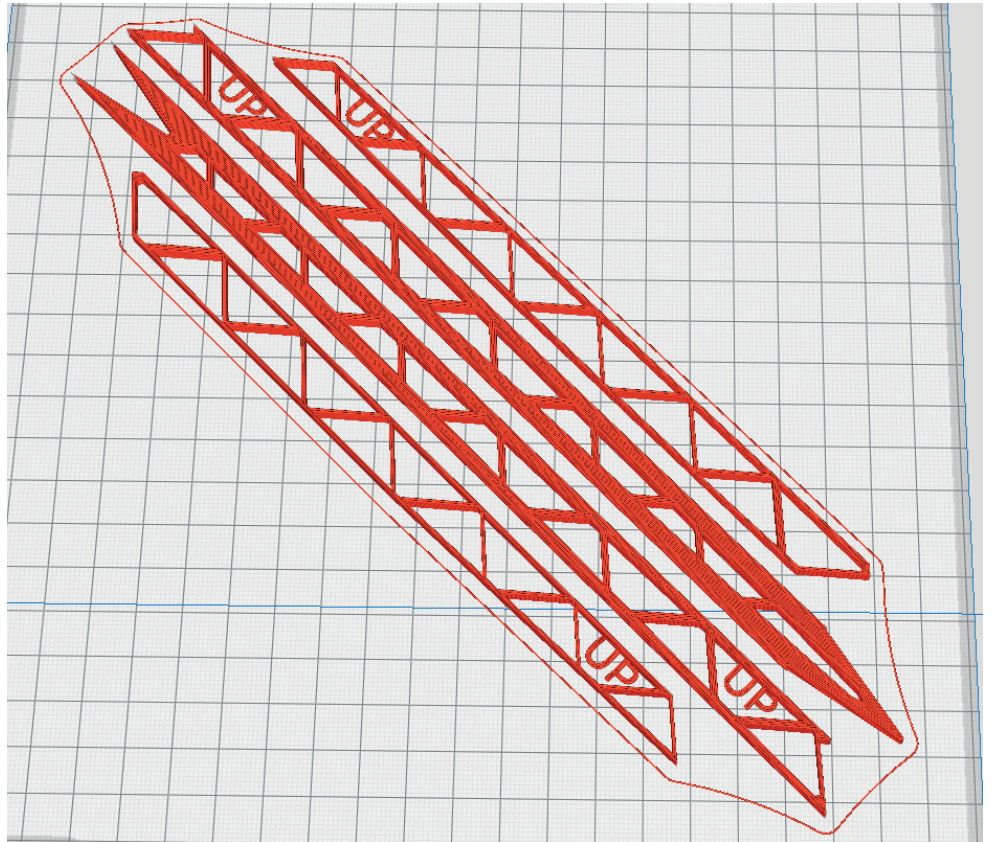

PROFILE P2_HOLLOWBODY

The following parts must be sliced with the profile P2_HOLLOWBODY.
Recommended additional settings are listed in the screenshots.

INFO

STL file: Fuselage spar-p2.stl
Material: PLA
Weight: ~ 7 g

ADDITIONAL SETTINGS

- Skirt

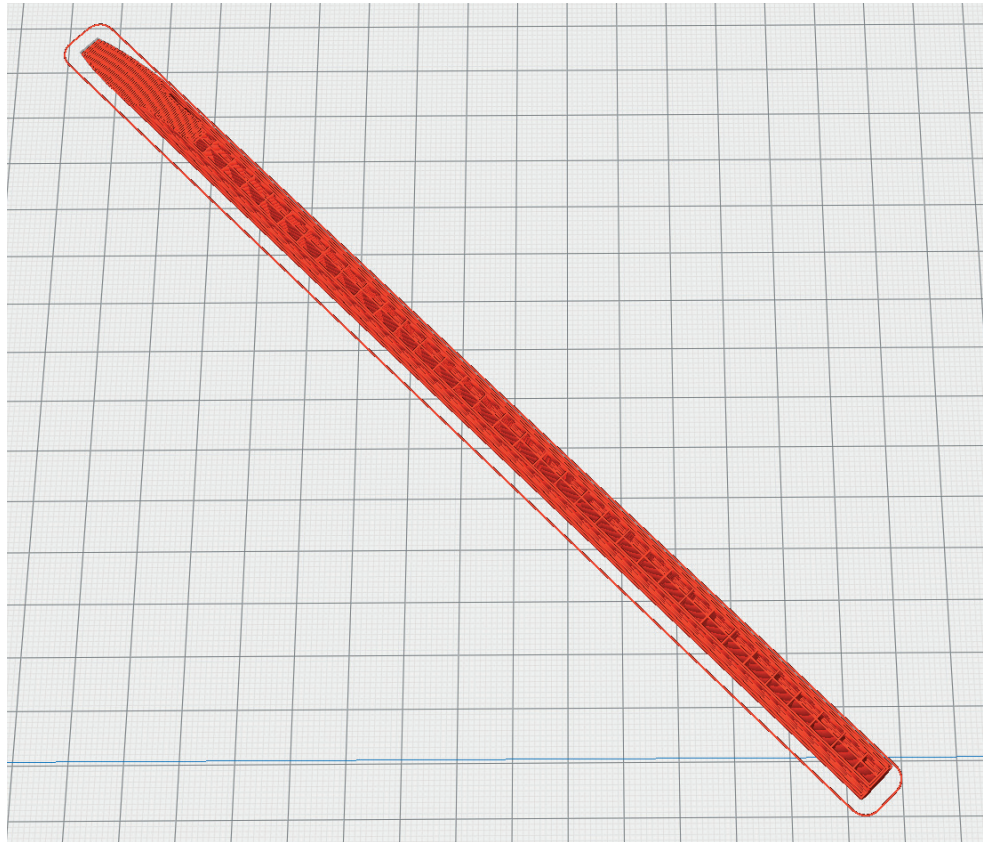

PROFILE P3_SURFACE

The following parts must be sliced with the profile PROFILE P3_SURFACE (1 Wall Print).
Recommended additional settings are listed in the screenshots.

PLEASE NOTE

In profile P3_SURFACE, there should not be more than one STL on the buildplate at the same time, otherwise slicing errors can occur!

INFO

STL files: Ailerons-p3.stl
Material: PLA
Weight: ~ 20 g

ADDITIONAL SETTINGS

None required

PLEASE NOTE

The slots for the hinges hinges rest on the pressure plate and must be opened slightly with the cutter. Please be careful!

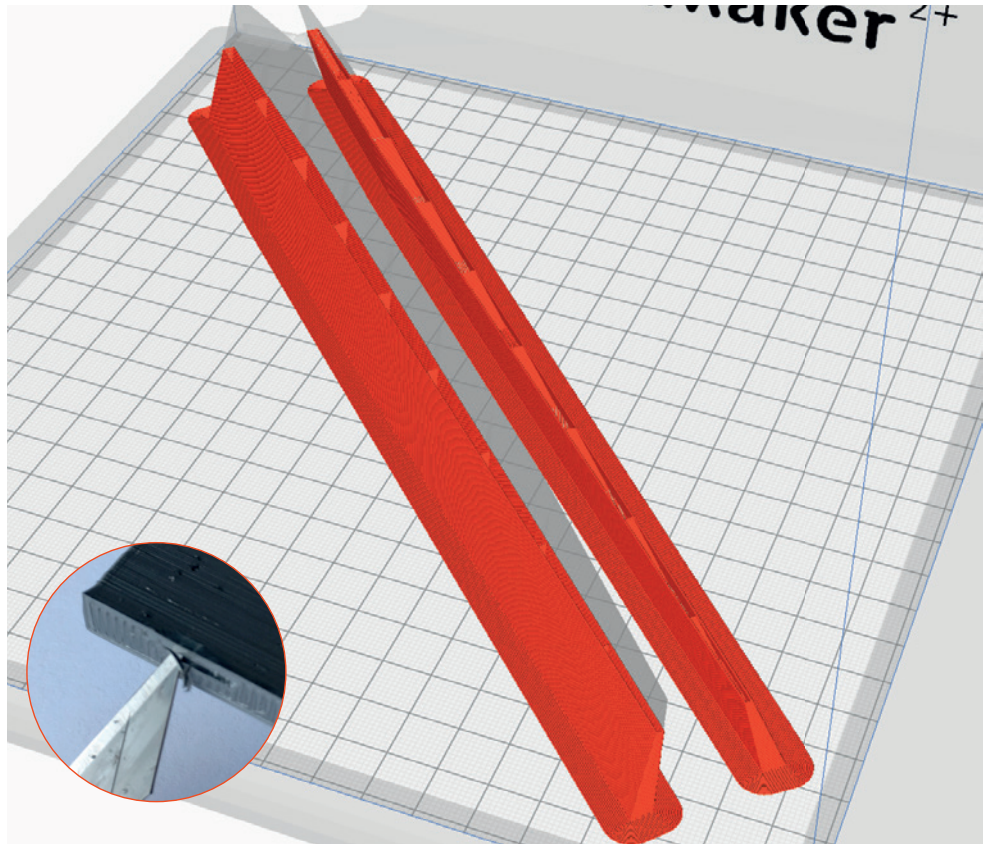

INFO

STL file: Cabin hood 1-p3.stl
Material: PLA
Weight: ~ 10 g

ADDITIONAL SETTINGS

None required

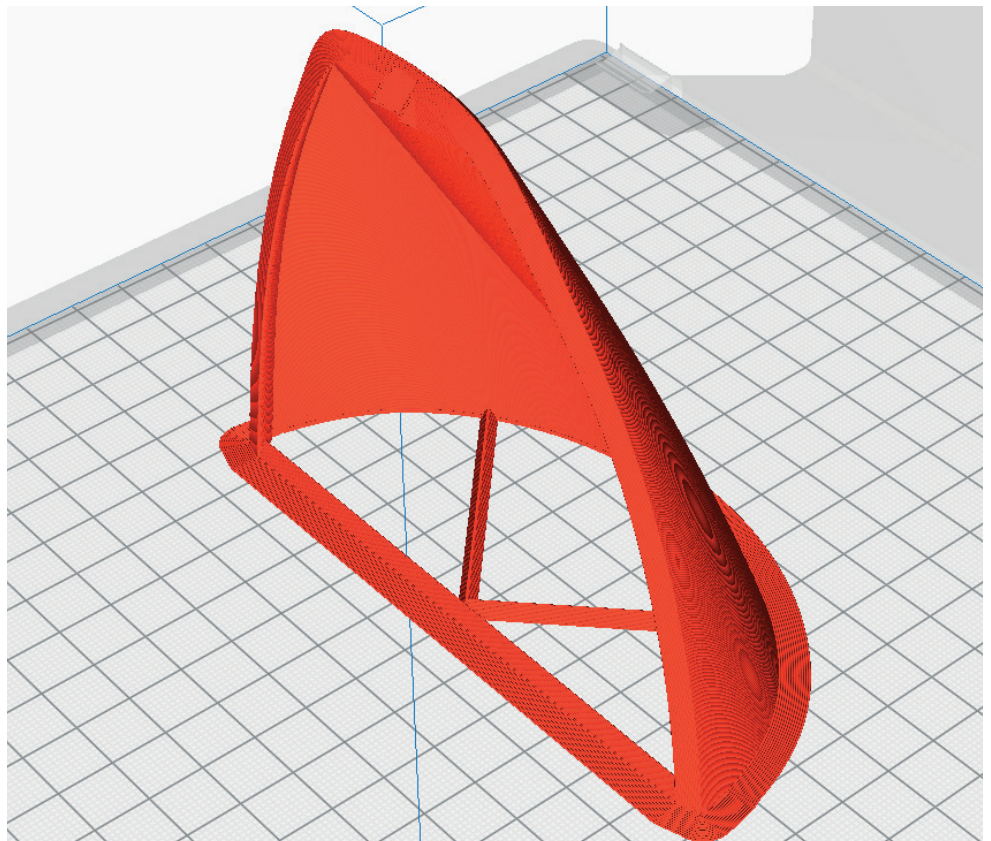

PROFIL P3_SURFACE

PLEASE NOTE

In profile P3_SURFACE, there should not be more than one STL on the buildplate at the same time, otherwise slicing errors can occur!

INFO

STL file: Cabin hood 2-p3.stl
Material: PLA
Weight: ~ 10 g

ADDITIONAL SETTINGS

None required

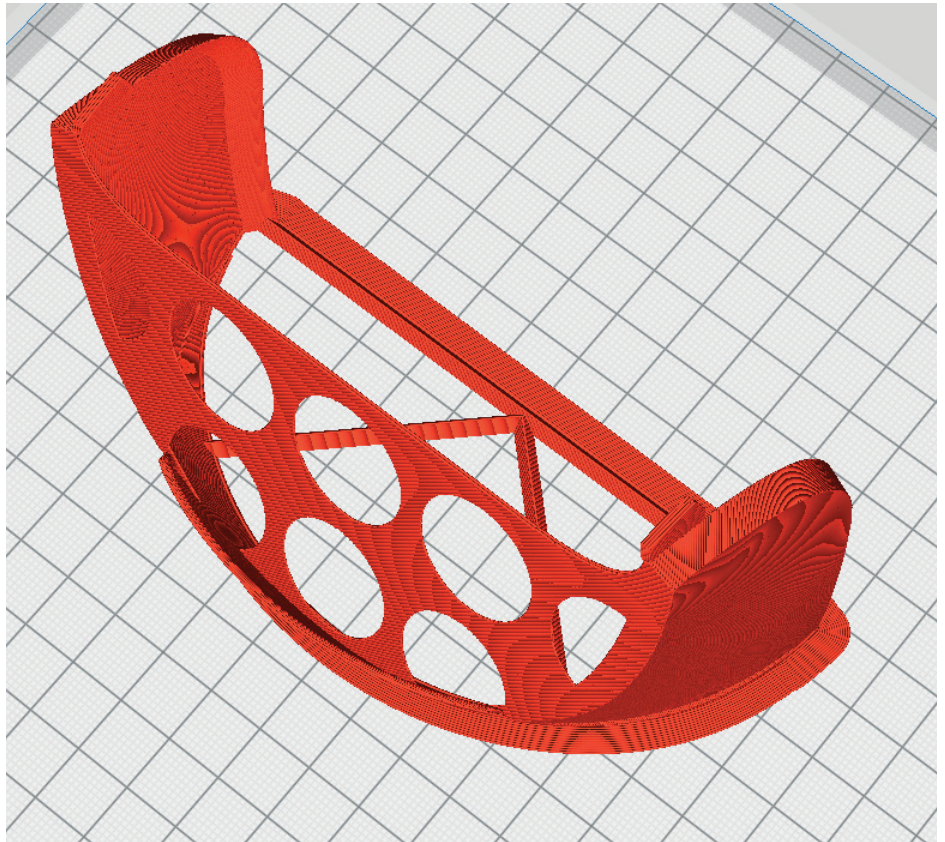

INFO

STL files: Elevator-p3.stl
Material: PLA
Weight: ~ 35 g

ADDITIONAL SETTINGS

None required

PLEASE NOTE

The slots for the hinges rest on the pressure plate and must be opened slightly with the cutter. Please be careful!

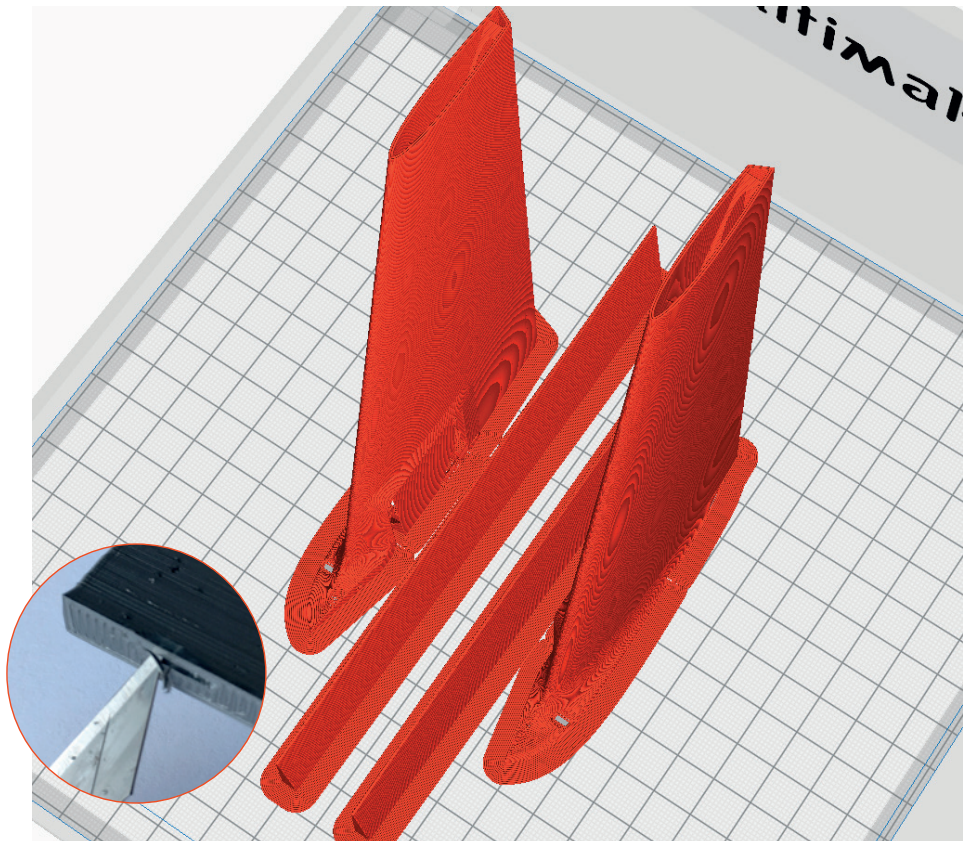

PROFILE P3_SURFACE

PLEASE NOTE

In profile P3_SURFACE, there should not be more than one STL on the buildplate at the same time, otherwise slicing errors can occur!

INFO

STL files: Engine pod 1-p3.stl
 Material: PLA
 Weight: ~ 10 g

ADDITIONAL SETTINGS

None required

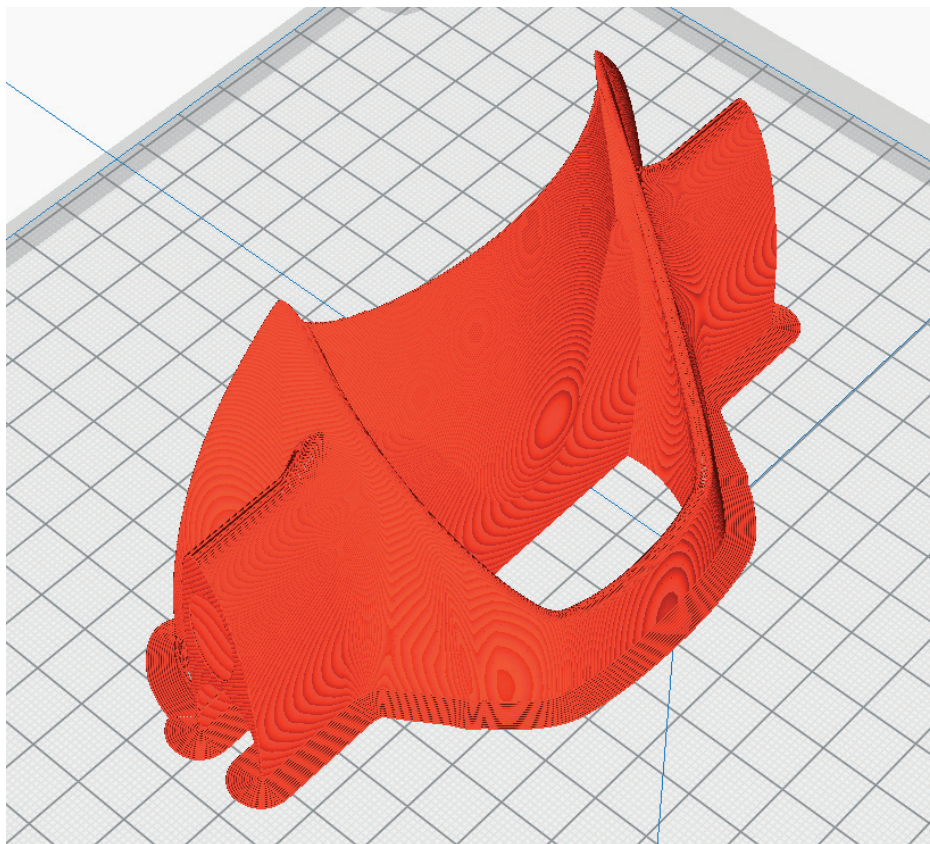

INFO

STL files: Engine pod 2-p3.stl
 Material: PLA
 Weight: ~ 24 g

ADDITIONAL SETTINGS

With good print adhesion
 no brim necessary.

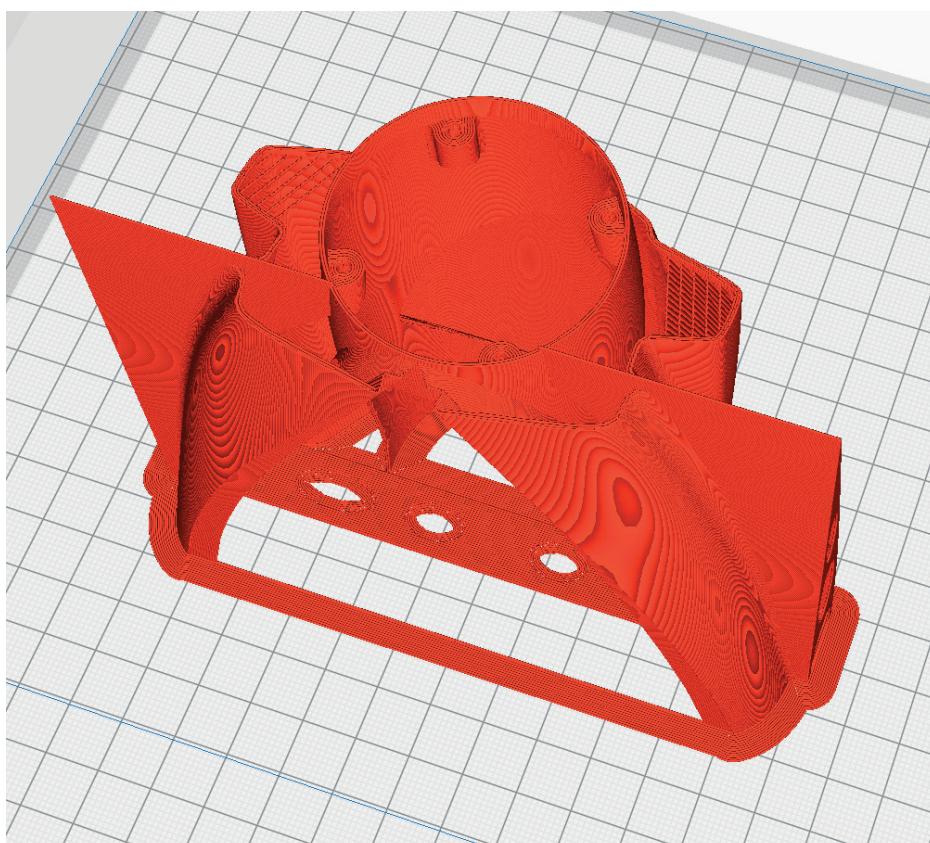

PROFILE P3_SURFACE

PLEASE NOTE

In profile P3_SURFACE, there should not be more than one STL on the buildplate at the same time, otherwise slicing errors can occur!

INFO

STL files: Fuselage 2-p3.stl
Material: PLA
Weight: ~ 23 g

ADDITIONAL SETTINGS

None required

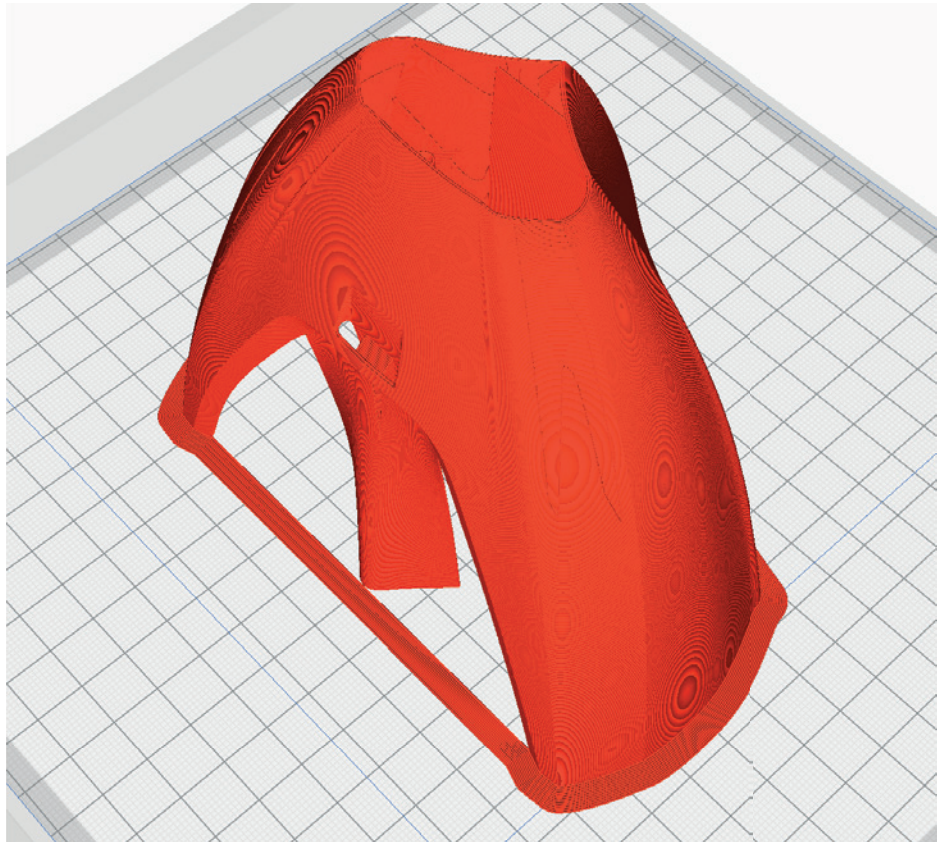

INFO

STL files: Fuselage 3-p3.stl
Material: PLA
Weight: ~ 39 g

ADDITIONAL SETTINGS

None required

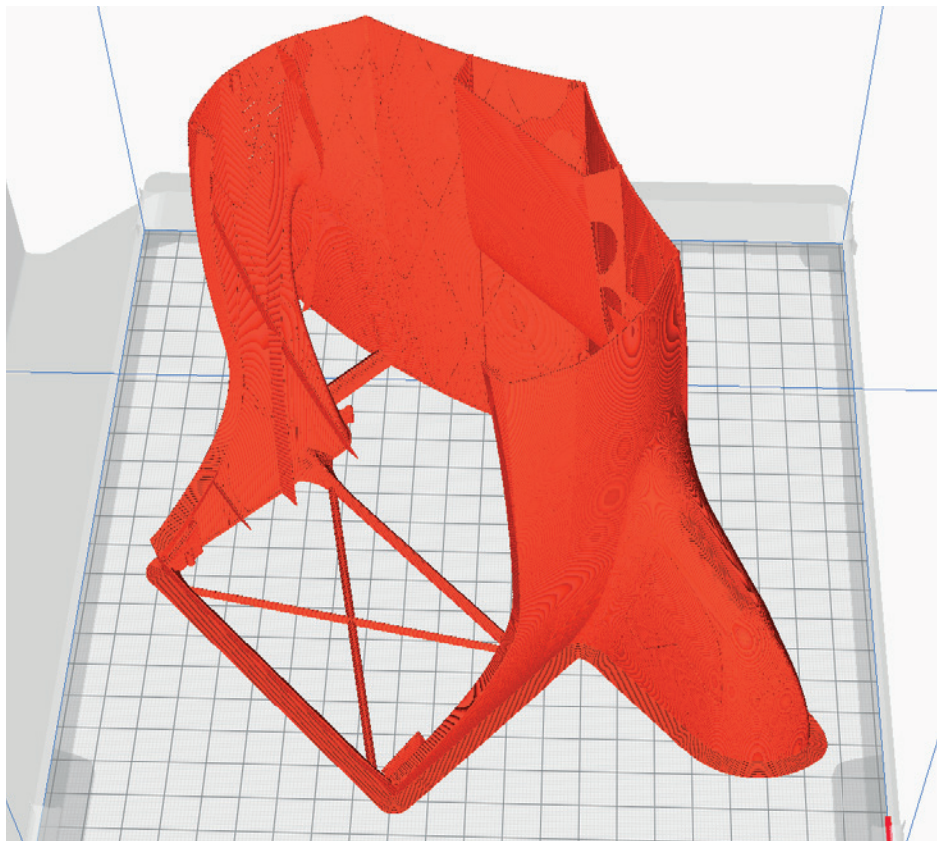

PROFILE P3_SURFACE

PLEASE NOTE

In profile P3_SURFACE, there should not be more than one STL on the buildplate at the same time, otherwise slicing errors can occur!

INFO

STL files: Fuselage 4-p3.stl
Material: PLA
Weight: ~ 48 g

ADDITIONAL SETTINGS

None required

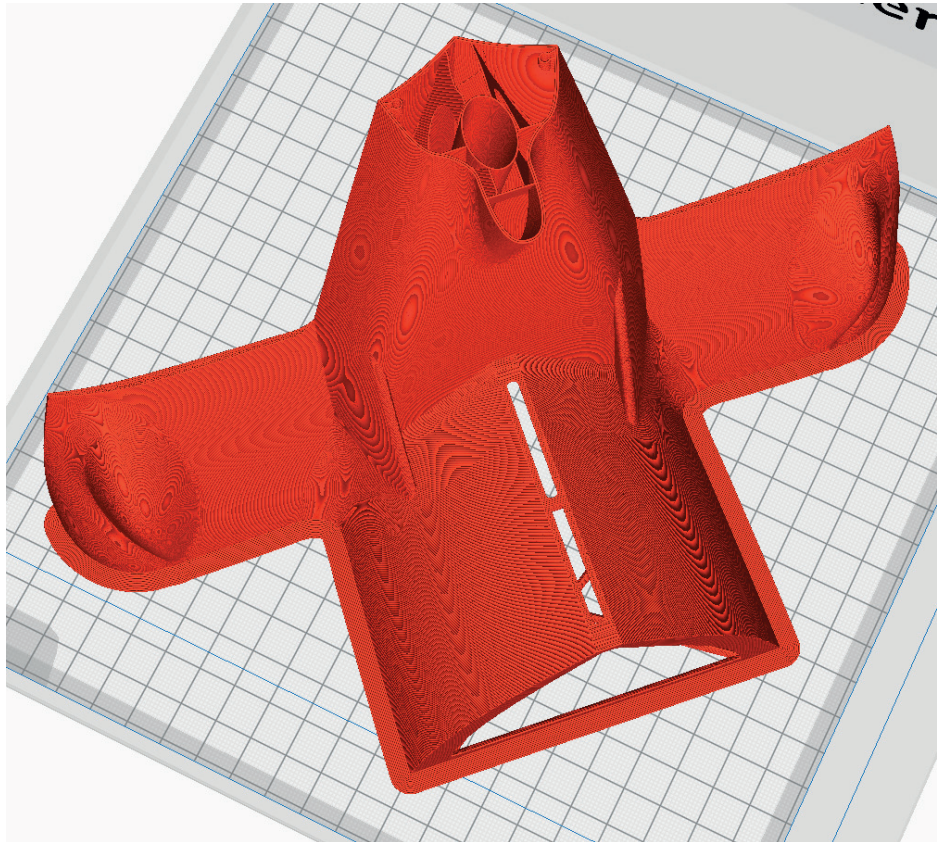

INFO

STL files: Fuselage 5-p3.stl
Material: PLA
Weight: ~ 12 g

ADDITIONAL SETTINGS

So that the end edge does not get too hot, you should print with fan in the last third, about 60% or generally print this component with a fan speed of 30-60% (the layer adhesion has to be good, because the fuselage is exposed to high loads!)

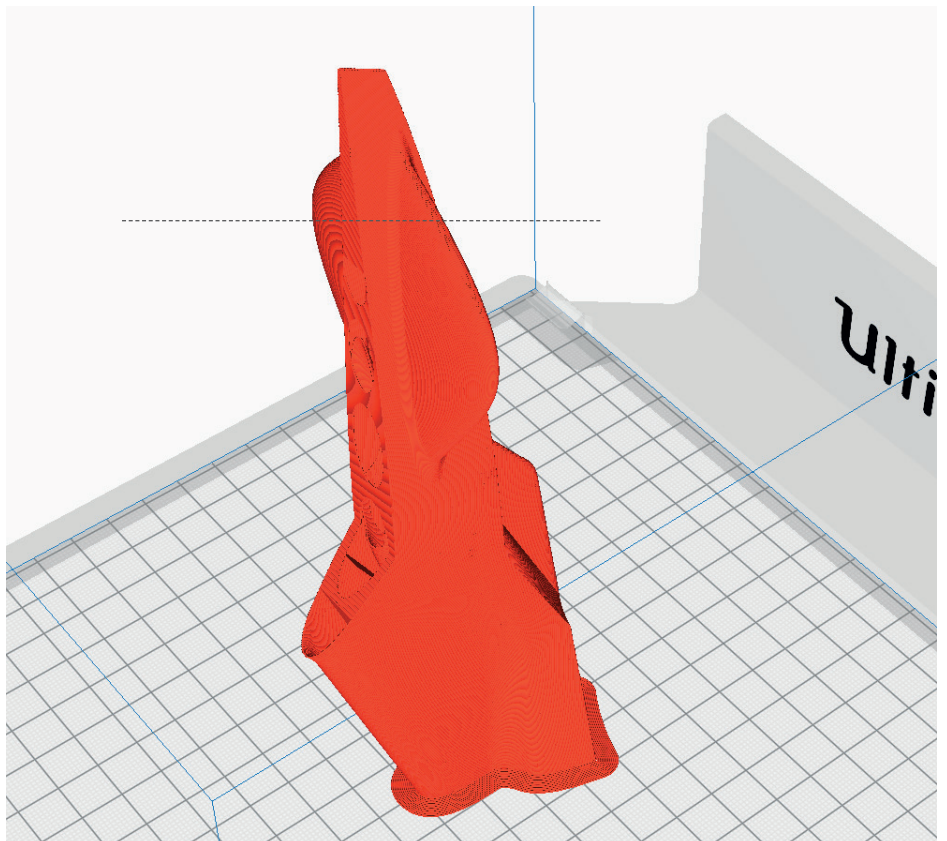

PROFILE P3_SURFACE

PLEASE NOTE

In profile P3_SURFACE, there should not be more than one STL on the buildplate at the same time, otherwise slicing errors can occur!

INFO

STL files: Rudder-p3.stl
Material: PLA
Weight: ~ 24 g

ADDITIONAL SETTINGS

None required

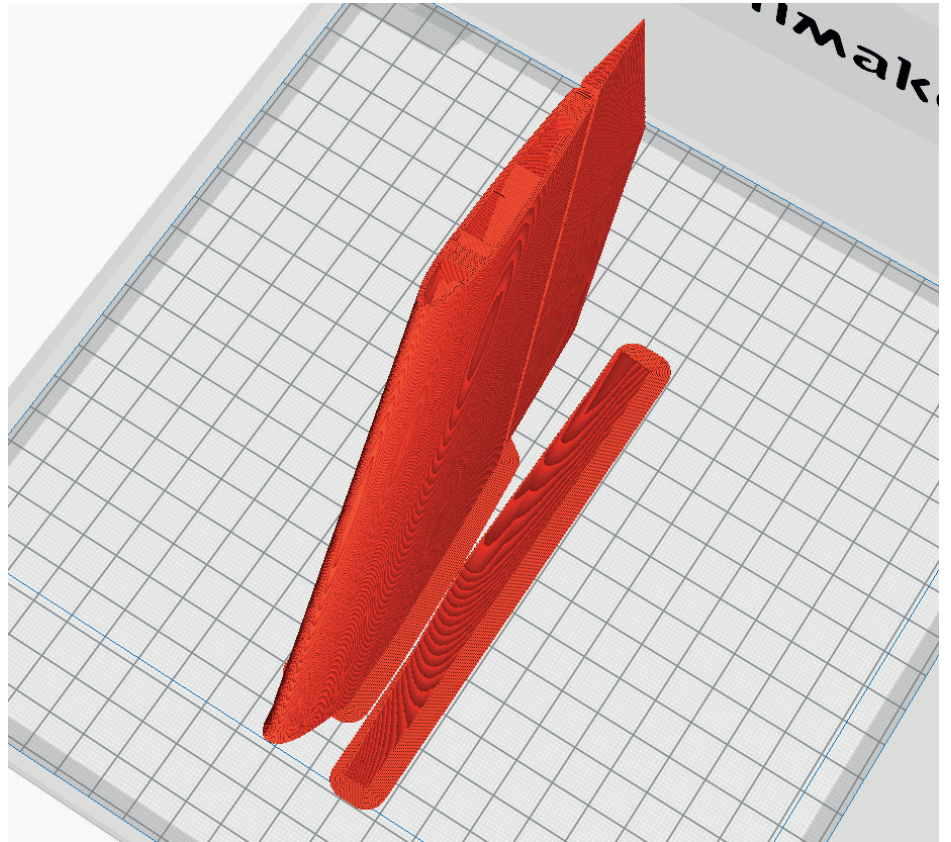

INFO

STL files: Wing 1-p3.stl
Material: PLA
Weight: ~ 48 g

ADDITIONAL SETTINGS

None required

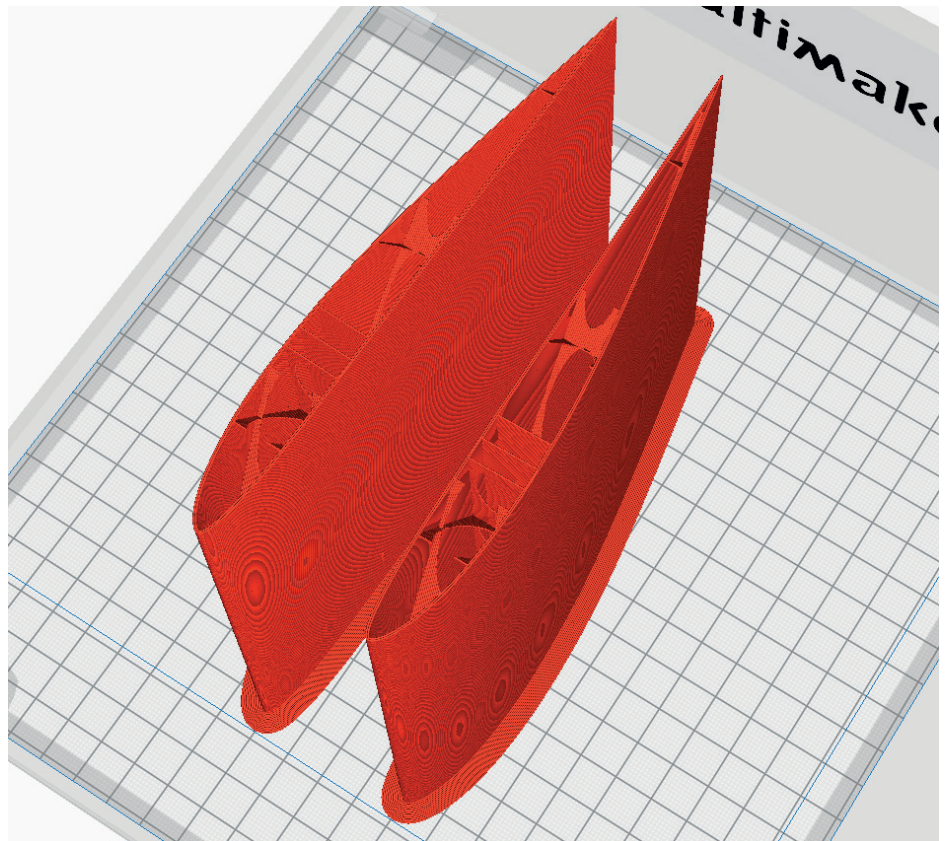

PROFILE P3_SURFACE

PLEASE NOTE

In profile P3_SURFACE, there should not be more than one STL on the buildplate at the same time, otherwise slicing errors can occur!

INFO

STL files: Wing 2-p3.stl
Material: PLA
Weight: ~ 44 g

ADDITIONAL SETTINGS

None required

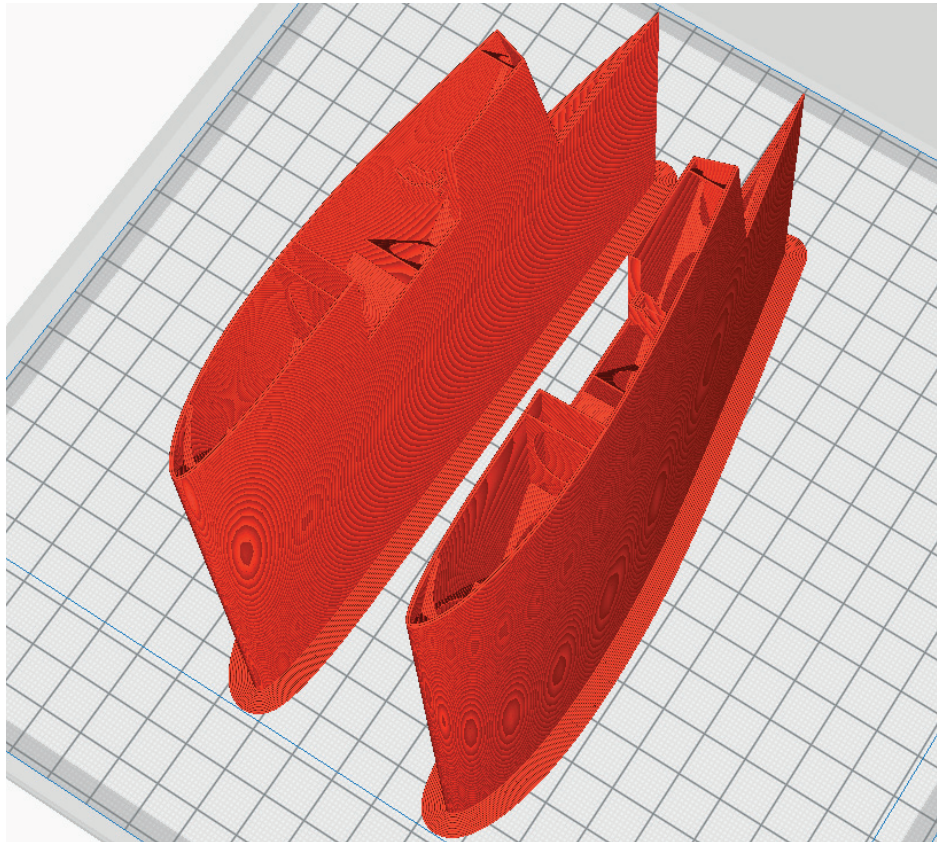

INFO

STL files: Wing 3-p3.stl
Material: PLA
Weight: ~ 39 g

ADDITIONAL SETTINGS

None required

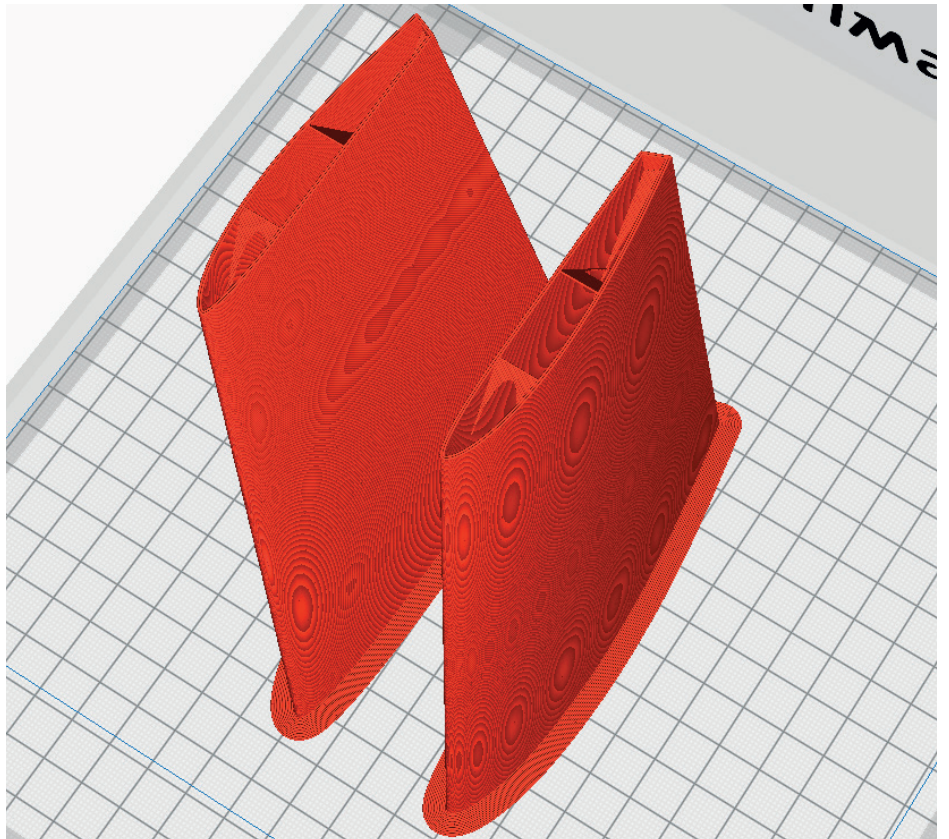

PROFILE P3_SURFACE

PLEASE NOTE

In profile P3_SURFACE, there should not be more than one STL on the buildplate at the same time, otherwise slicing errors can occur!

INFO

STL files: Wingtips-p3.stl
Material: PLA
Weight: ~ 11 g

ADDITIONAL SETTINGS

None required

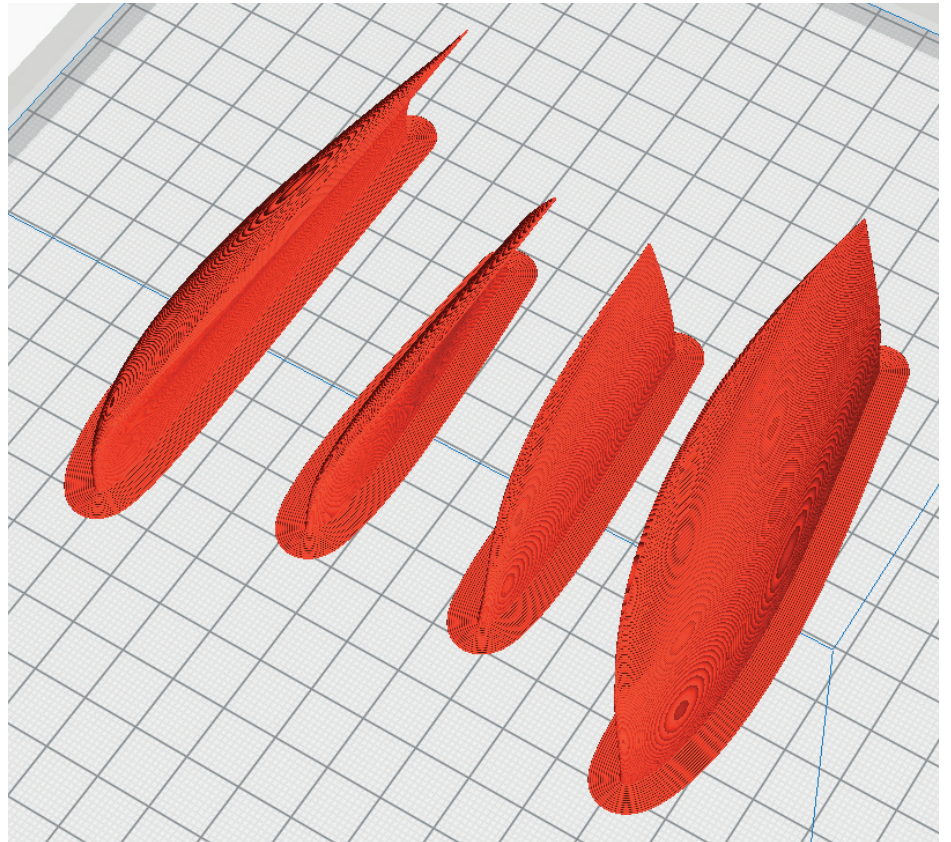

PROFILE P4_FLEX

The following parts must be sliced with the profile PROFILE P4_FLEX (flexible materials). Recommended additional settings are listed in the screenshots.

INFO

STL file: Hinges-p4.stl
Material: TPU soft or middel
Weight: ~ 1 g

ADDITIONAL SETTINGS

None required

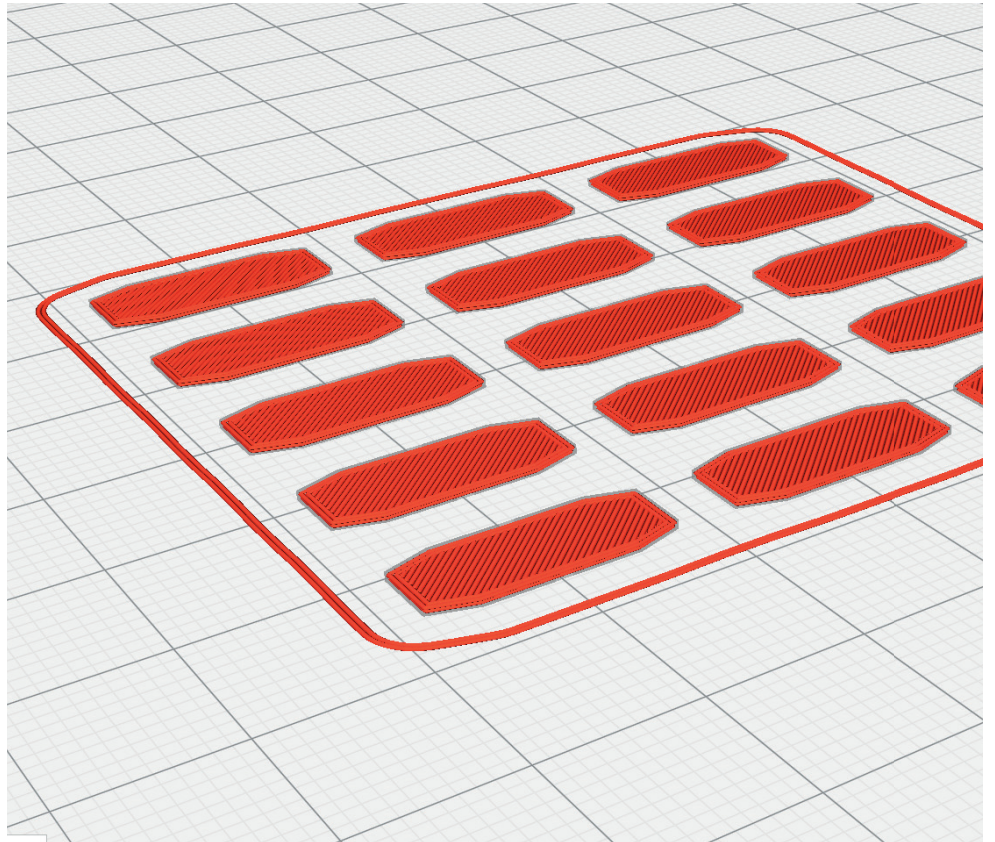

REQUIRED ACCESSORIES

MATERIALS

- tapping screws M2*10 8 Pieces
- tapping screws M2*16 3 Pieces
- CA super glue, liquid and liquid medium
- Activator
- servo extension cable
- double-sided adhesive tape (padded)
- steel wire Ø 0,6 mm or 1 mm
- Neodym-Super-Magnet
5x5x5mm 2 Pieces
- rod connection 4 Pieces



RC COMPONENTS

- Engine:
- Turnigy D2826-10 1400kv Brushless
 - Torcster Brushless Gold A2826/10-1400

- Picco Servo 4 Pieces:
(max. 23x26x8,5mm)
- Hitec HS 40 Eco Servo 4,8g
 - EMAX ES9051 Digital Servo 4,1g
 - PLANET-HOBBY ECO PLUS
 - PICCO 8 DIGITAL SERVO
 - Diamond D47

- BEC-Controller: 3S, min. 25A, BEC

- Prop: 7045 7x4.5" 3-blade Counter Rotating
Propeller CW CCW Blade-Black
(can be used left and right turning when
the motor direction is reversed)

Battery pack (~170 g): 3S LiPo-Akku ca. 1.800 – 2.200 MAH

TOOLS

- Cutter knife
- Philips screwdriver
- Needle nose pliers

TIPP

We recommend the purchase of a small range of screws, which can be used for all future PLANEPRINT models.

Simply search the Internet for: [M2 Flat Head Tapping Screw Assortment ...](#)



CONSTRUCTION MANUAL



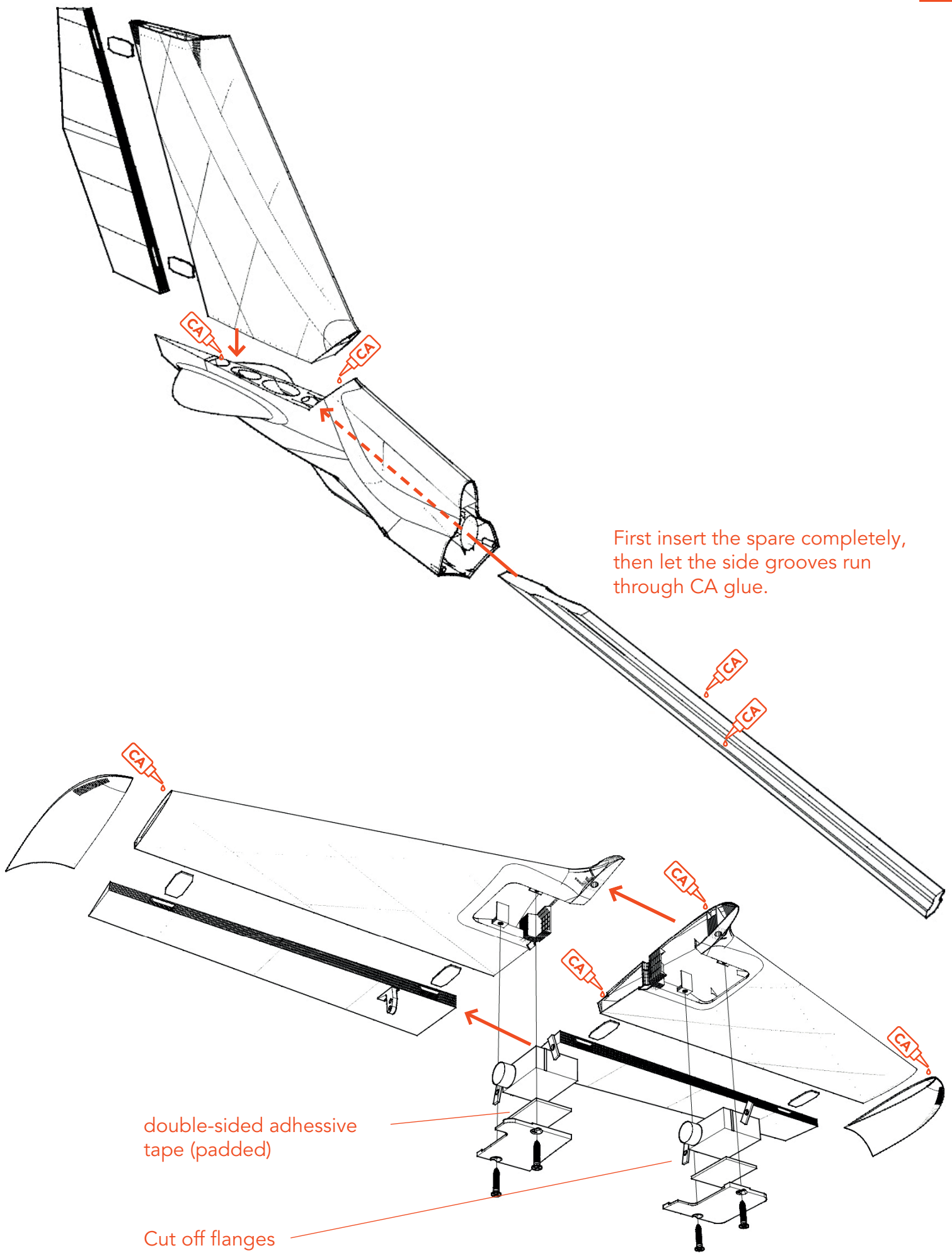

First insert the spare completely, then let the side grooves run through CA glue.

double-sided adhesive tape (padded)

Cut off flanges

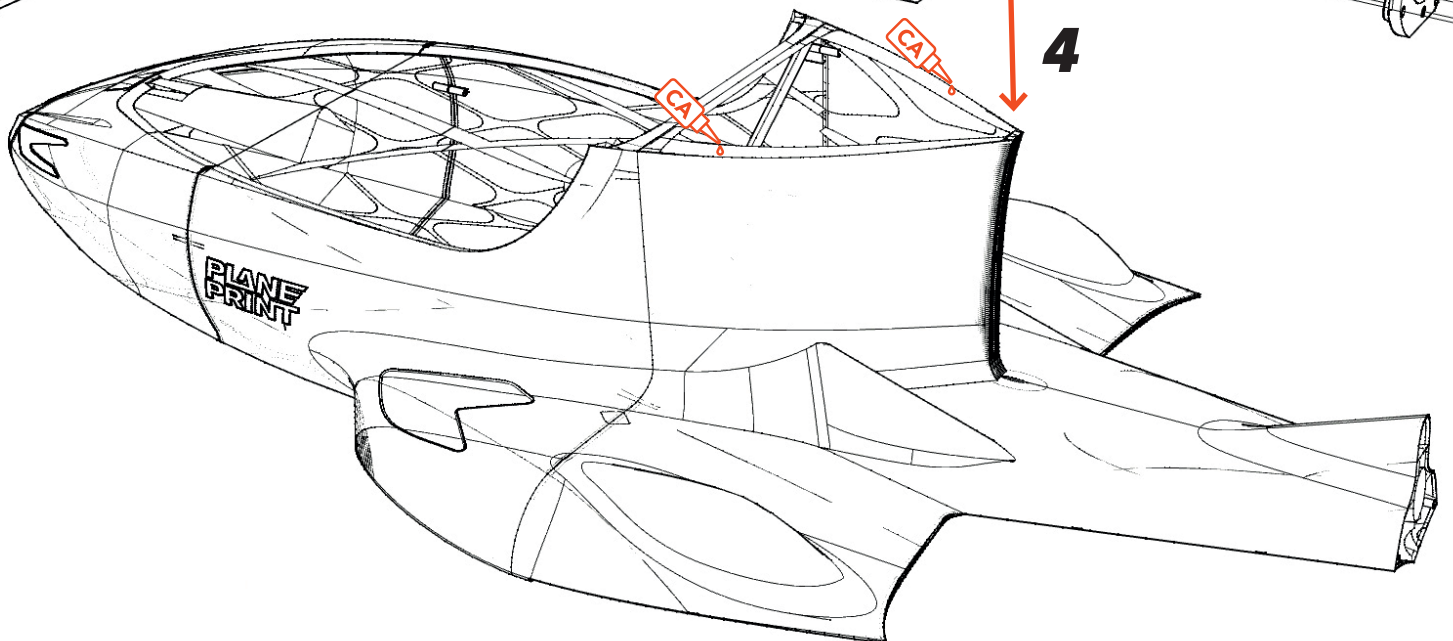
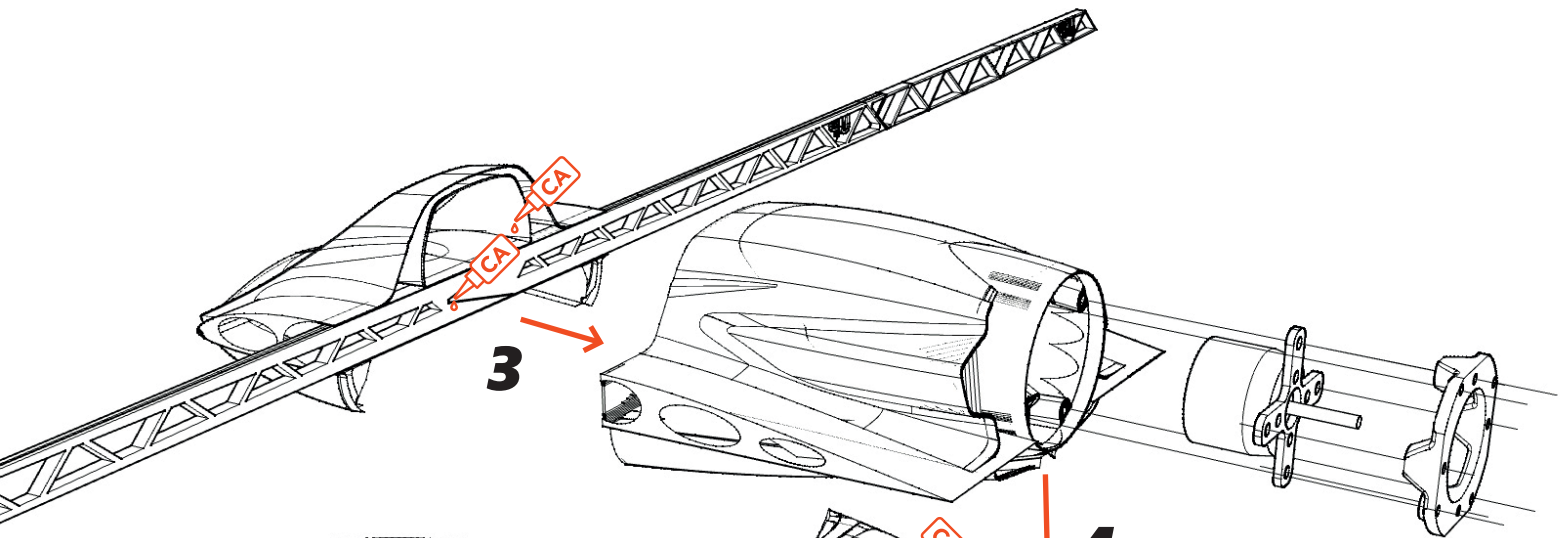
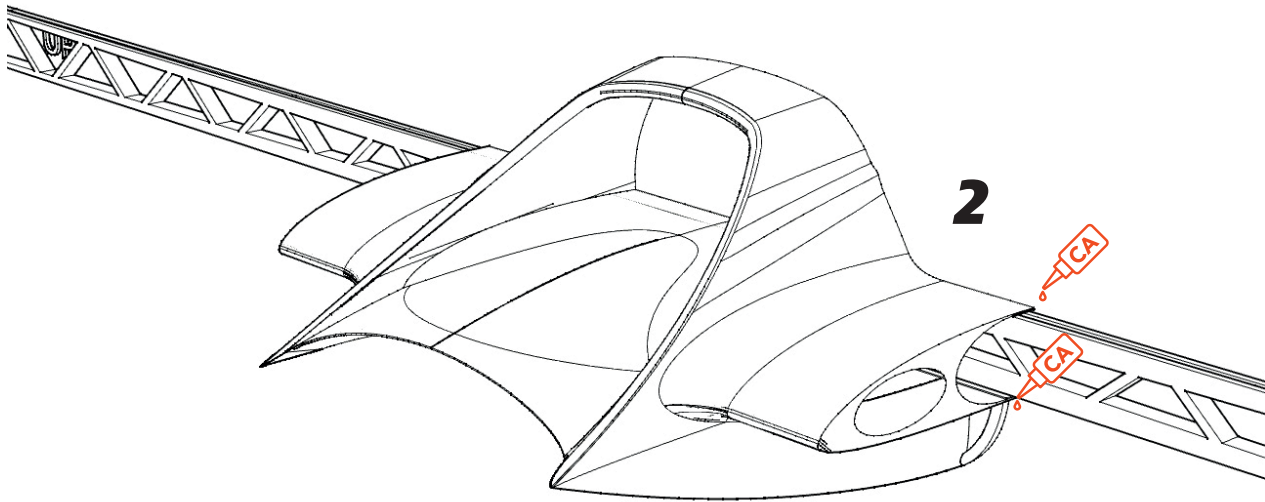

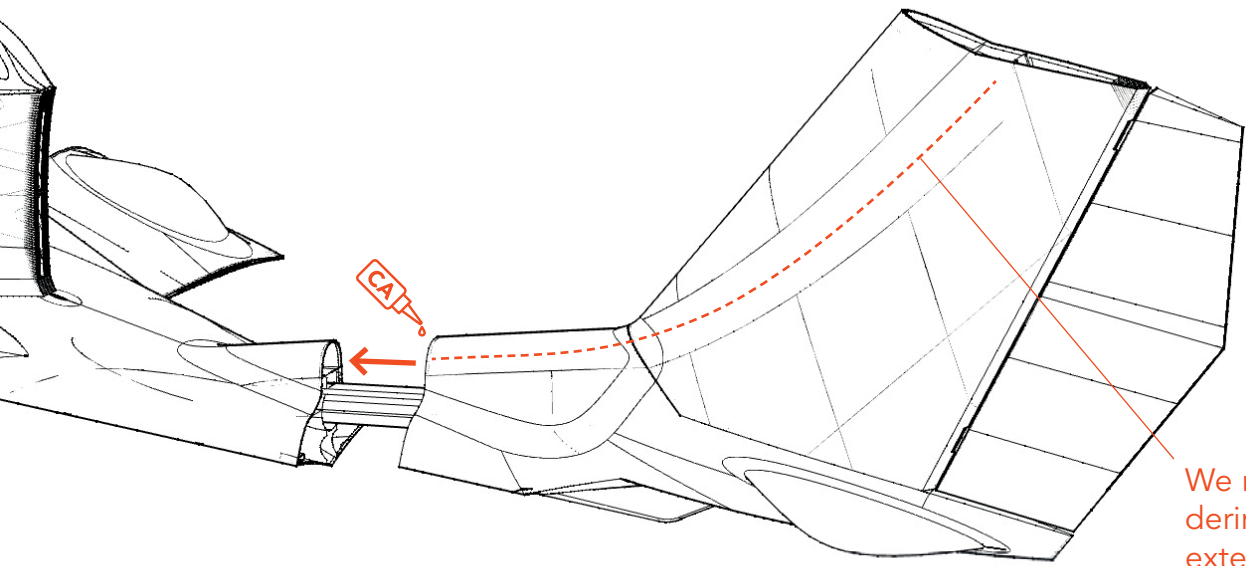

We recommend soldering the servo cable extensions directly to the servo cable. If you want to use connectors, please check first if they fit through the cable duct!

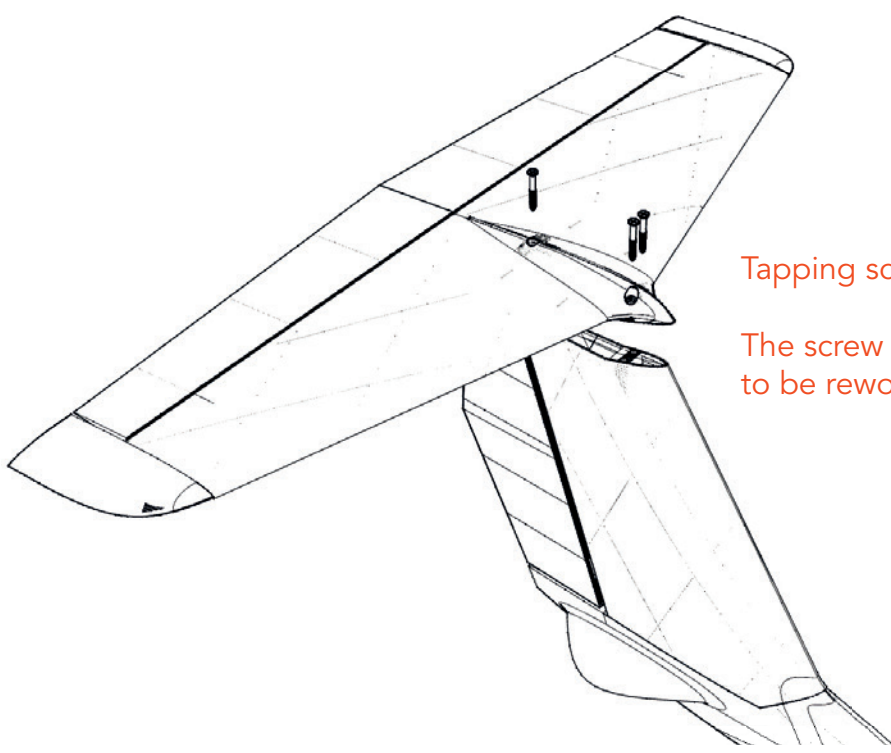

Tapping screw M2*16
The screw holes may need to be reworked

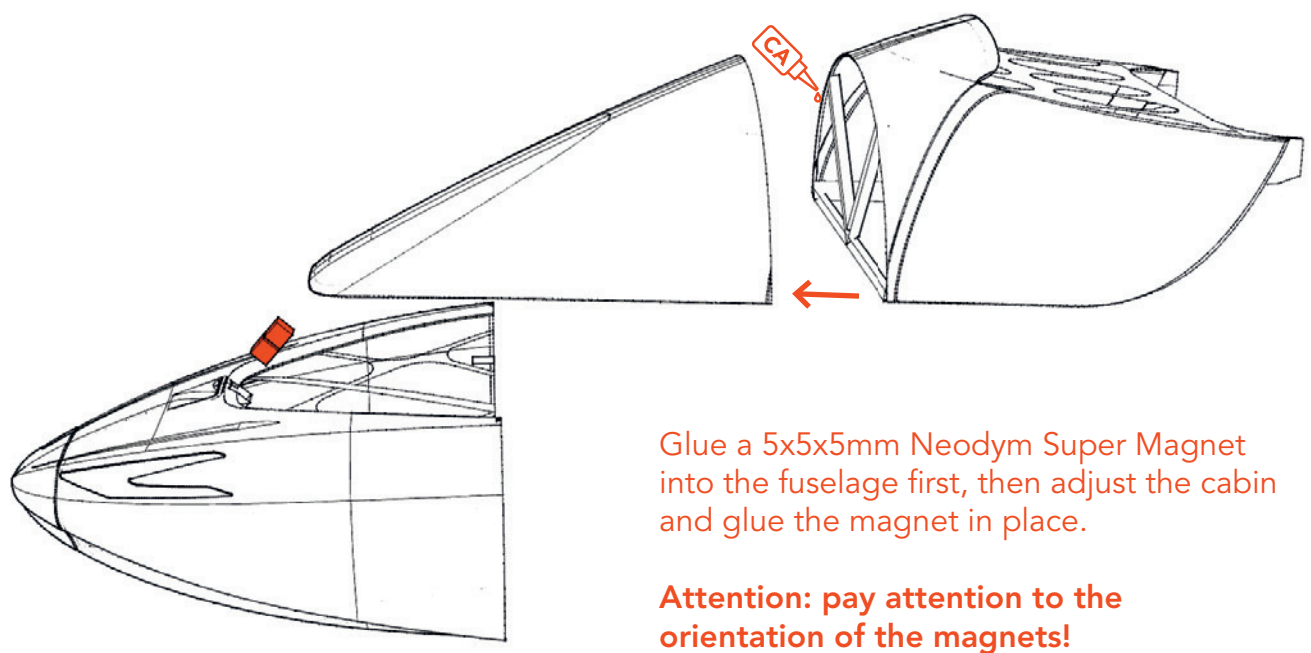

Glue a 5x5x5mm Neodym Super Magnet into the fuselage first, then adjust the cabin and glue the magnet in place.

Attention: pay attention to the orientation of the magnets!

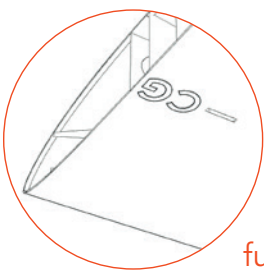

The CG mark on the underside must point towards the fuselage!



Free the servo cable duct from the brim before sticking!

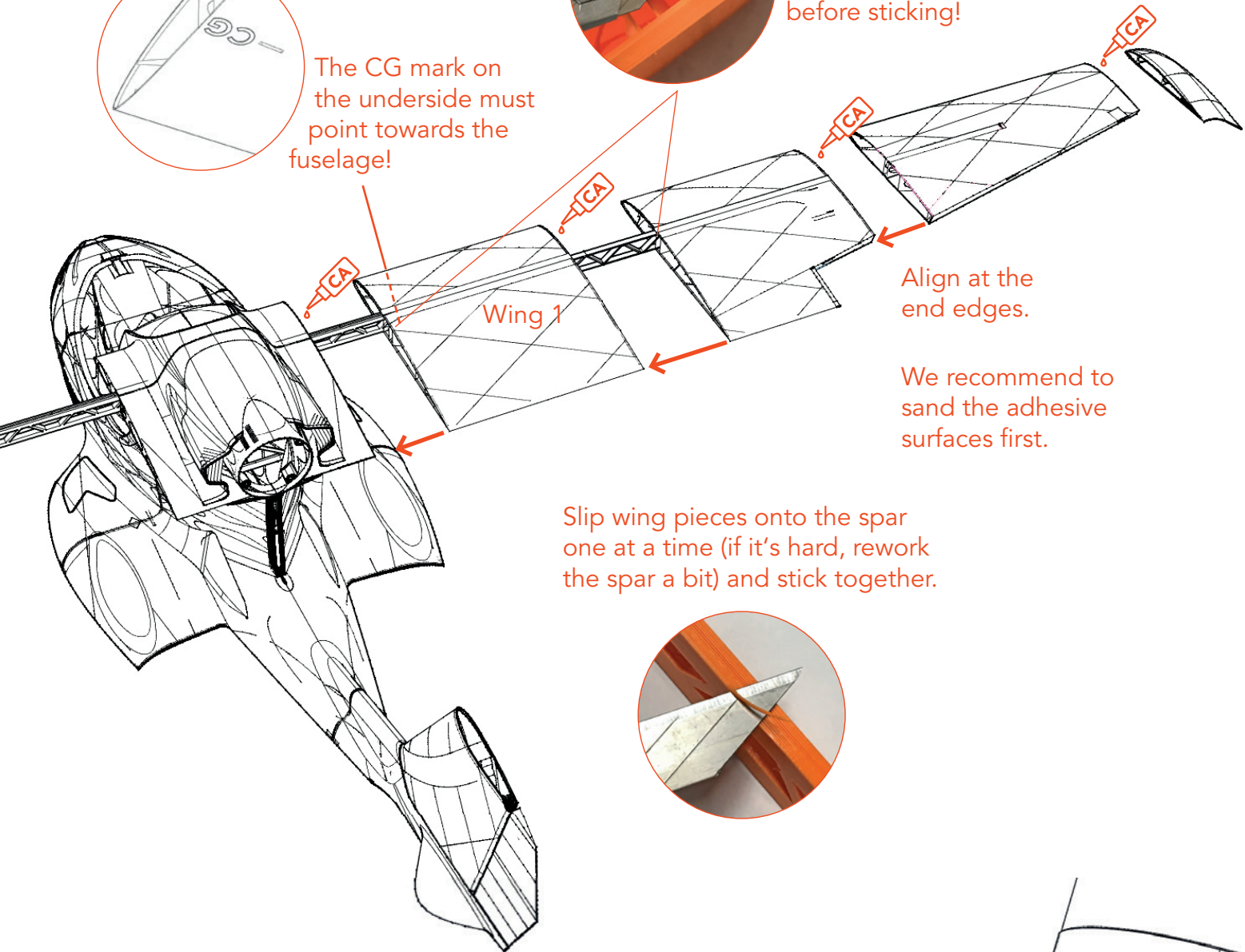

Align at the end edges.

We recommend to sand the adhesive surfaces first.

Slip wing pieces onto the spar one at a time (if it's hard, rework the spar a bit) and stick together.

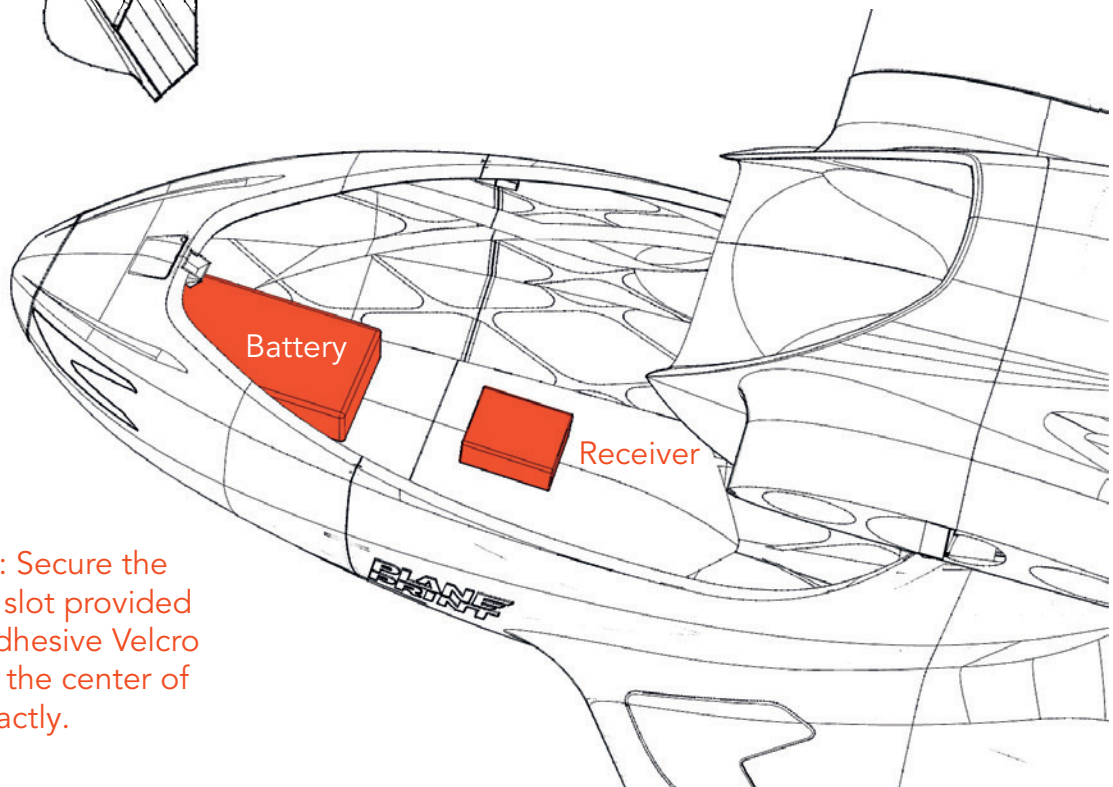

Battery installation: Secure the LiPo battery in the slot provided by means of self-adhesive Velcro tape. Align so that the center of gravity (CG) fits exactly.

DETAIL PHOTOS

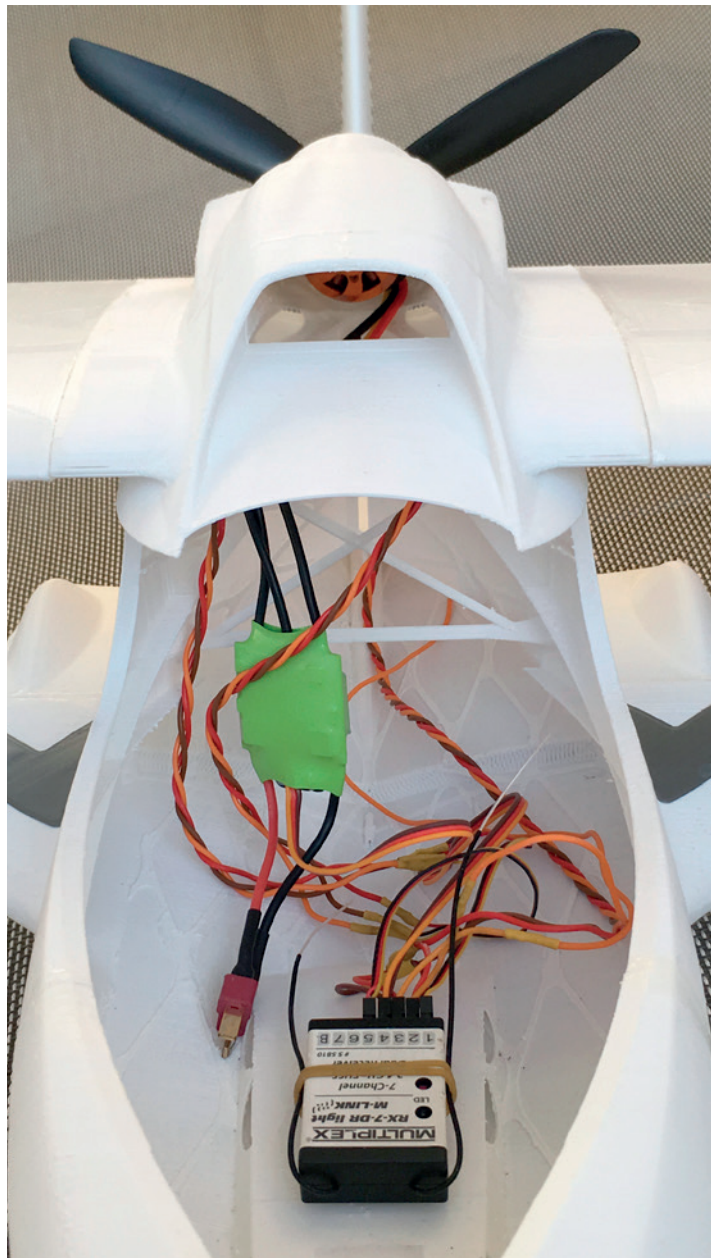
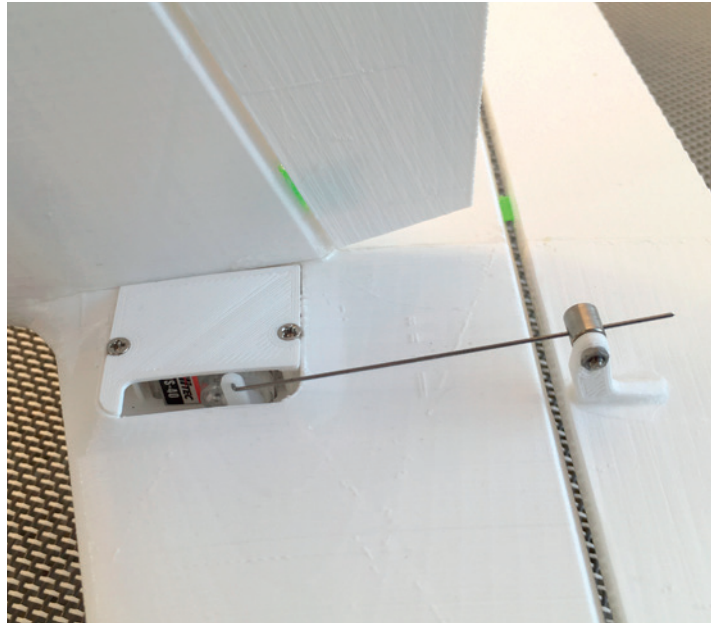
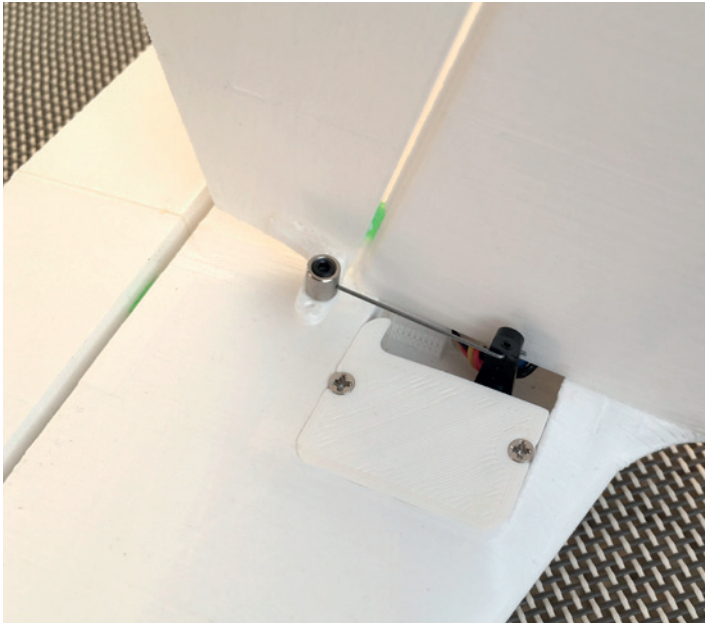

DETAIL PHOTOS

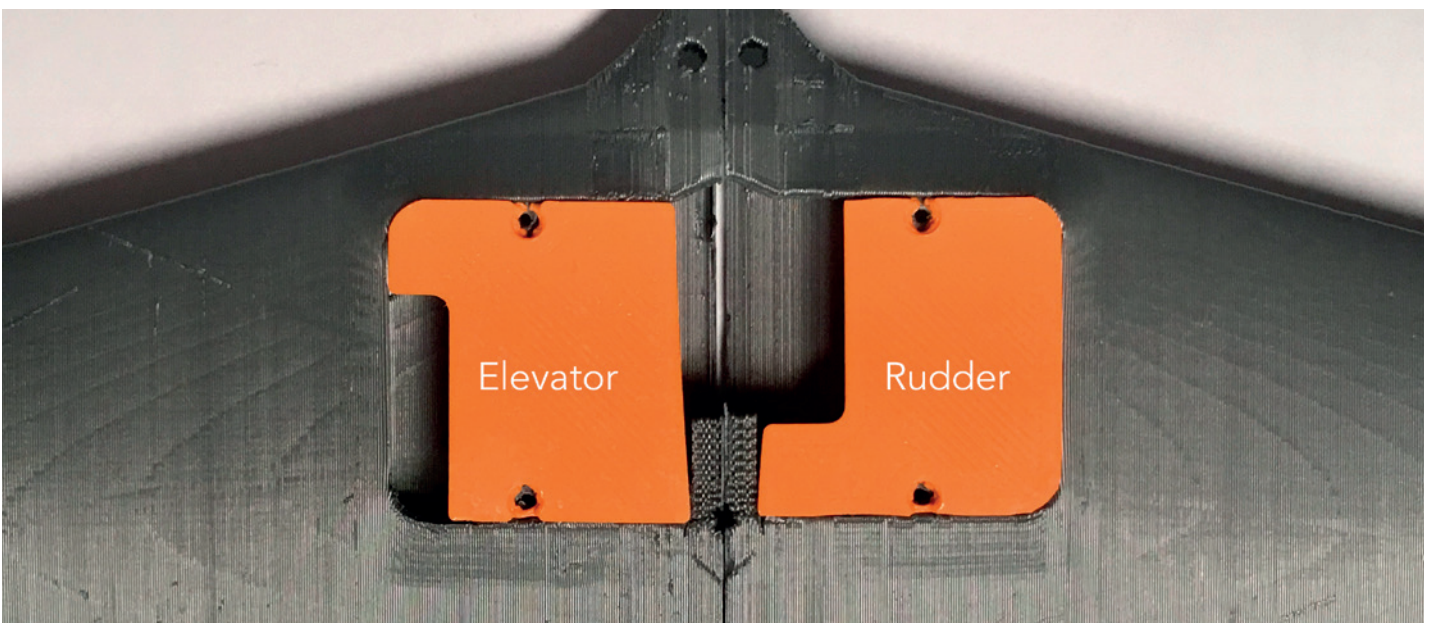
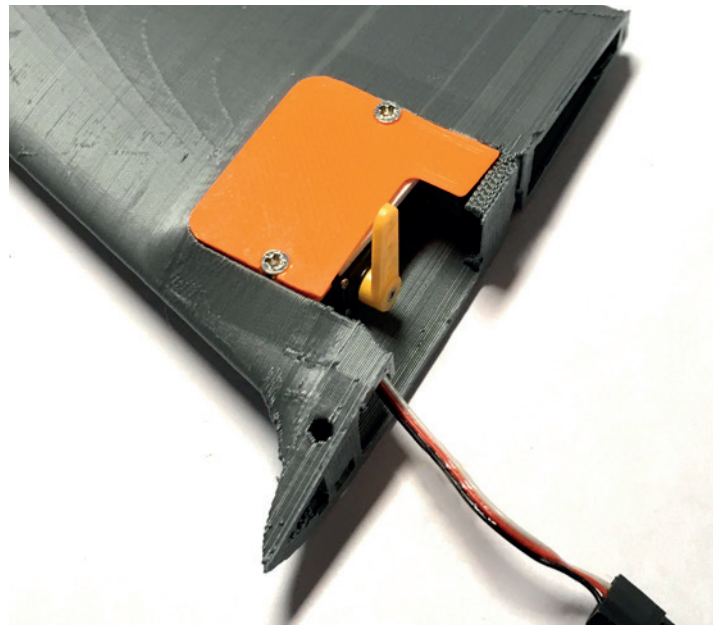
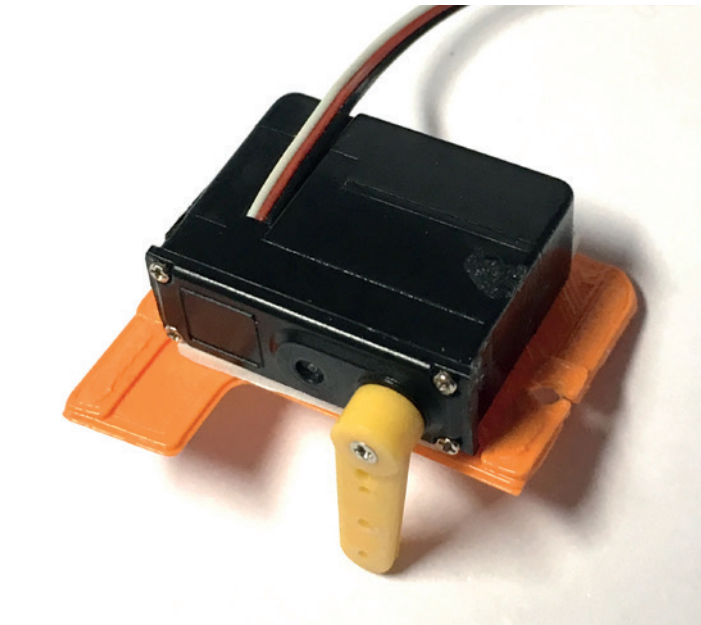

DETAIL PHOTOS

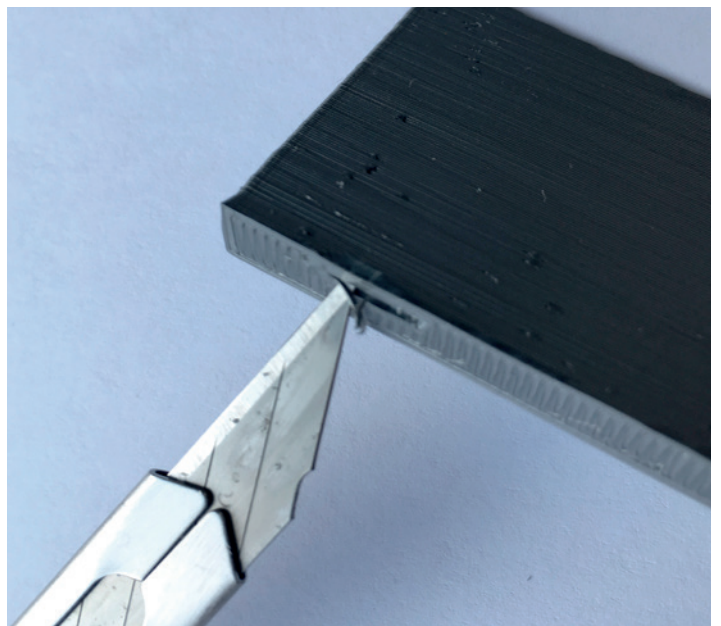
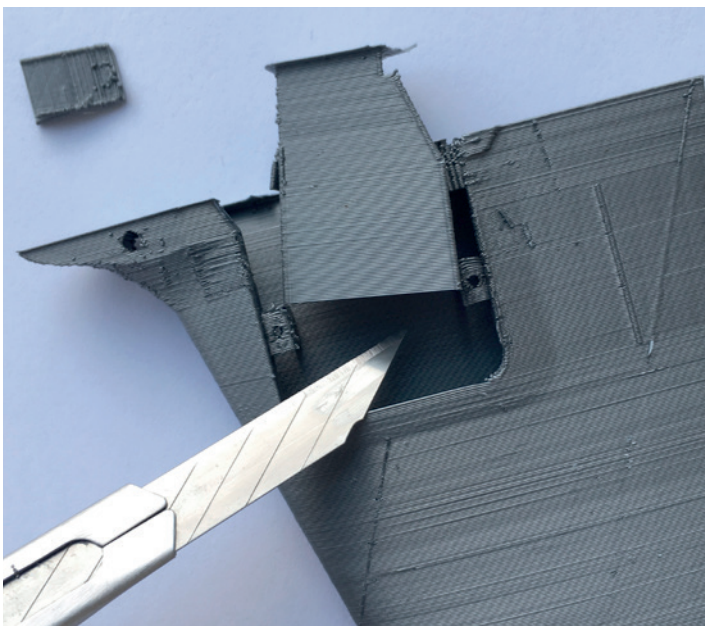
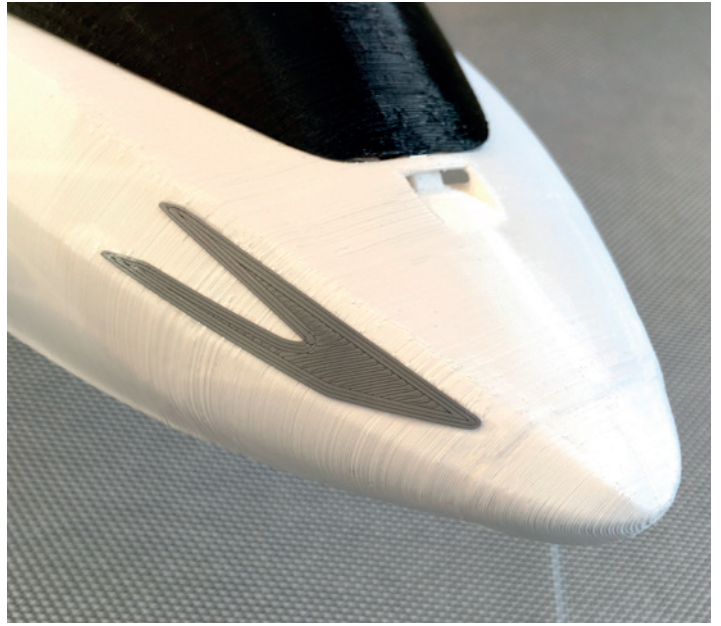
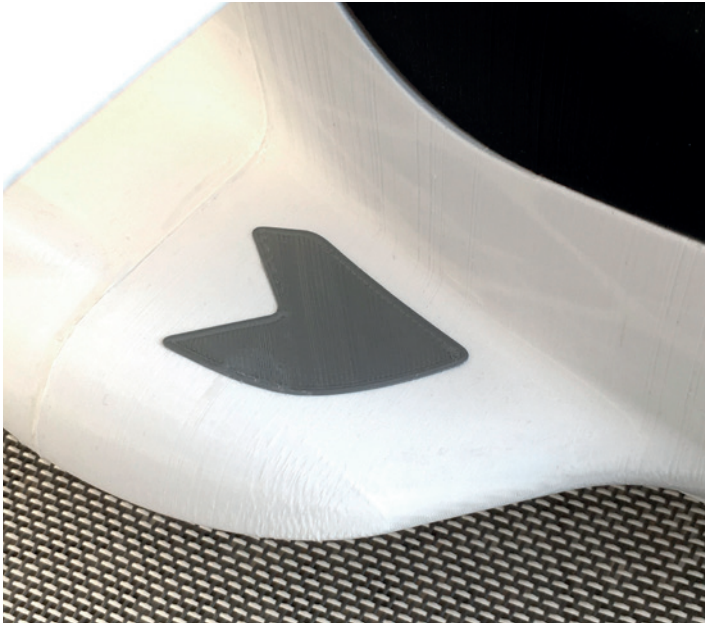

QUICK START GUIDE

After installing the electronics and setting up the transmitter, check that the control surfaces are aligned correctly. Set the transmitter trim to zero. The ailerons should be aligned with the trailing edge of the wing tip. Then align the flaps with the ailerons. The elevator should be aligned with

the horizontal stabilizer and the rudder to the vertical stabilizer. Change the position of the moving parts by changing the length of the linkage from the servo arm to the control horn. In-flight adjustments can be made later with the trim.

TRANSMITTER CONFIGURATION

1. Select empty (Acro) model
2. Wing type: 2 ailerons
3. Reversing the direction of servo as required (see control function)
4. Servo adjustment all: 100%

EXPO SETTING

	ADVANCED	BEGINNER
Aileron	15 %	30 %
Elevator	15 %	30 %
Rudder	0 %	20 %

SETTING THE SERVO TRAVEL

- Aileron ▲ = 12 mm
▼ = 10 mm
- Elevator ▲ = 10 mm
▼ = 10 mm
- Rudder ◀ = 16 mm
▶ = 16 mm

FLIGHT TIMER

Flight time will vary depending on the battery size. Expect 7 minutes under normal circumstances; however, it may be possible to fly for much longer. It is a good idea to be conservative with the flight timer until you gain experience with your airplane.

CENTER OF GRAVITY (CG)

45 mm behind the leading edge (see markings on the wing). For the first flight we recommend to move the center of gravity about 5 mm further forward.

TECHNICAL SPECIFICATIONS

737 mm (29 inches)

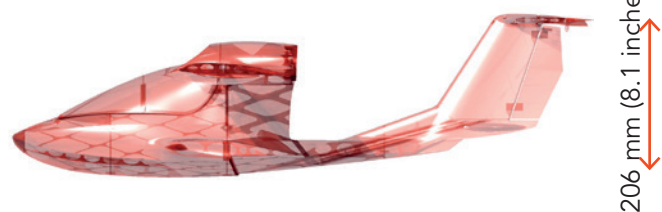

1100 mm (43.3 inches)

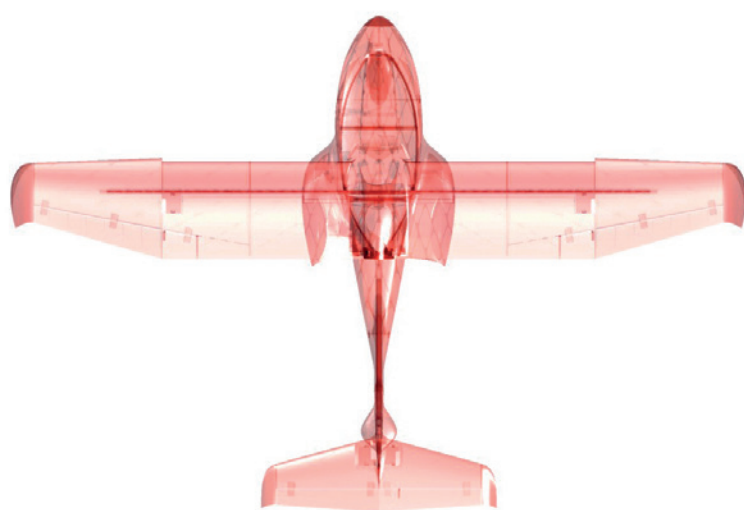

206 mm (8.1 inches)

FLYING WEIGHT:

~ 740 g, depending on features and 3D printing

CONTROL DIRECTION TEST

Turn on the transmitter and connect the battery. When checking the control directions, look at the aircraft from behind.

1. Move the aileron lever to the left. The right aileron should move down and the left aileron should move up so that the aircraft tilts to the left.
2. Move the aileron lever to the right. The right aileron should move up and the left aileron down so that the aircraft is tilting to the right.
3. Pull back the elevator lever. The elevators should move up, causing the aircraft to rise.
4. Push the elevator lever forward. The elevator should move down so that the aircraft sinks.
5. Move the rudder lever to the left. The rudder should move to the left.
6. Move the rudder lever to the right. The rudder should move to the right.
7. Move the flap switch to position 2. The flaps should move down by the set value „half“.
8. Move the flap control switch to position 3. The flaps should move down by the set value „whole“.

AILERON

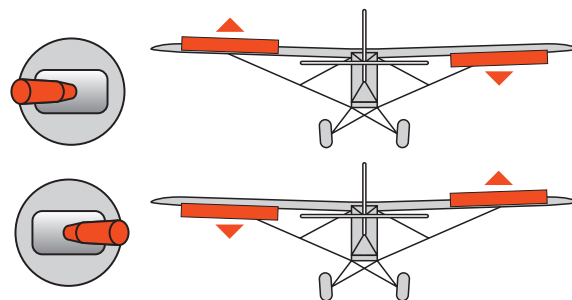

ELEVATOR

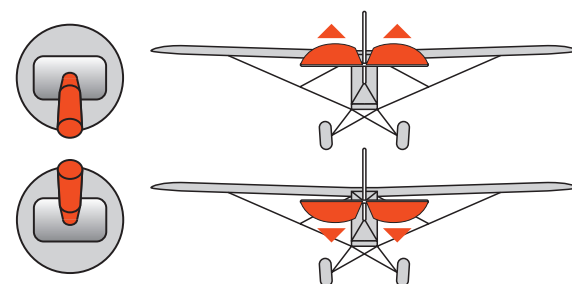

RUDDER

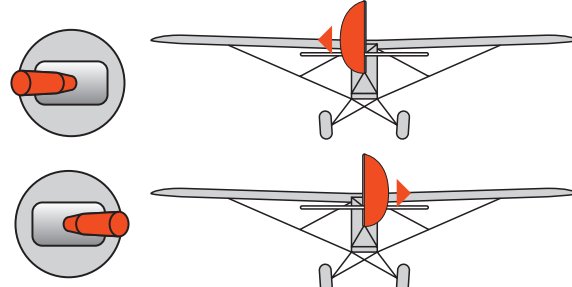

FIRST FLIGHT

Ground takeoff

The Icon A5 has enough power with the recommended setting to launch on a grass runway from the ground. We recommend adding some elevator from the beginning and keeping the wings with the ailerons horizontal. The use of the rudder is usually not necessary.

Takeoff from the hand

The start from the hand is also possible, here it should be noted that the aircraft pulls something down, because the engine is above the central axis. If there is no wind, a starting helper should be sought to ensure a safe start.

You keep the model like the picture on the bottom of the fuselage and keep enough distance to the prop. **Attention, risk of injury from the rotating propeller!.**

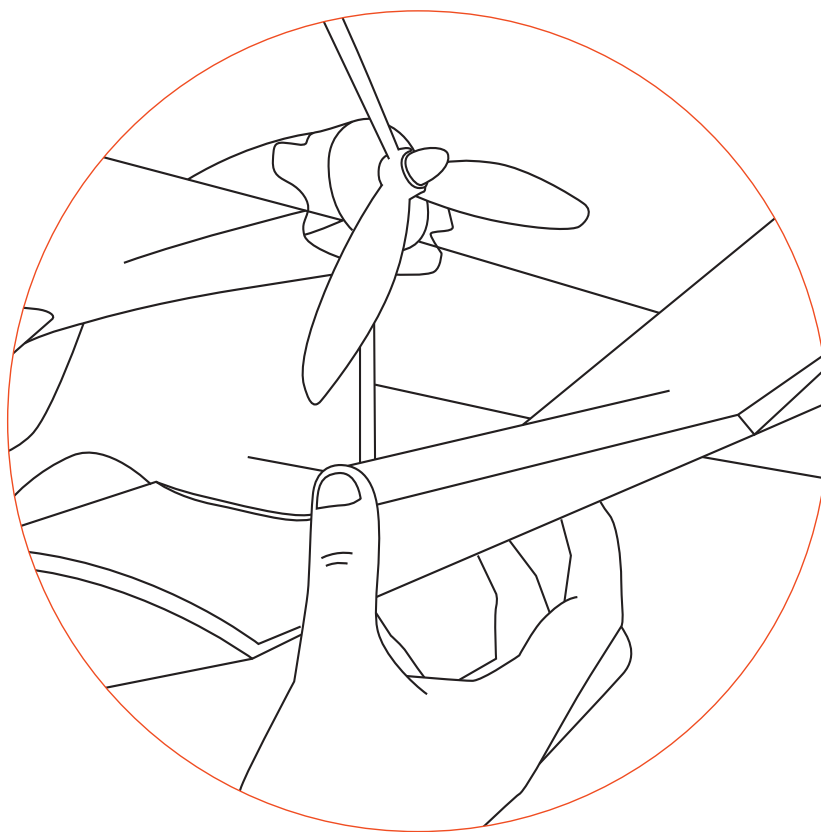

Takeoff at the water

We could not test the launch from the water yet, but we sealed a test fuselage and equipped it with the exact flight weight. The hull is well in the water and we think that takeoff and landing should not be a problem. **We ask for your understanding that we can not guarantee!**

If you want to try the water start, the hull must be sealed watertight on the side and at the bottom. The easiest way to do this is to paint it with a paint spray can from the outside. Best before the wings and the rudder are mounted. If any leaks remain, simply seal them with medium or thick CA superglue and activator spray. Battery and receiver should be packed watertight.

AGE RECOMMENDATION 14+

NOT FOR CHILDREN UNDER 14 YEARS. THIS IS NOT A TOY!

By using the download data, an RC model airplane, called „model“ for short, can be manufactured using a 3D printer. As a user of this model, only you are responsible for safe operation that does not endanger you or others, or that does not damage the model or property of others.

PLANEPRINT.com assumes no responsibility for damage to persons and property caused by pressure, transport or use of the product. Filaments, printing supplies, hardware or consumables that can not be used after faulty 3D printing will not be replaced by PLANEPRINT.com in any way.

When operating, always keep a safe distance from your model in all directions to avoid collisions and injuries.

This model is controlled by a radio signal. Radio signals can be disturbed from outside without being able to influence it. Interference can lead to a temporary loss of control.

Always operate your model on open terrains, far from cars, traffic and people.

Always follow the instructions and warnings for this product and any optional accessories (servos, receivers, motors, propellers, chargers, rechargeable batteries, etc.) carefully.

Keep all chemicals, small parts and electrical components out of the reach of children.

Avoid water contact with all components that are not specially designed and protected. Moisture damages the electronics.

Never take an item of the model or accessory in your mouth as this can lead to severe injuries or even death.

Never operate your model with low batteries in the transmitter or model.

Always keep the model in view and under control. Use only fully charged batteries.

Always keep the transmitter switched on when the model is switched on.

Always remove the battery before disassembling the model.

Keep moving parts clean and dry at all times.

Always allow the parts to cool before touching them.

Always remove the battery after use.

Make sure that the Failsafe is properly set before the flight.

Never operate the model with damaged wiring.

Never touch moving parts.

We develop our models to the best of our knowledge and belief.
We accept no liability for consequential damage and injuries caused by improper use. Please be careful when handling motors, batteries and propellers and only move your model with insurance and in approved places!

**PLANE
PRINT.com**

very light 3d printable rc planes

© PLANEPRINT.com, A-6020 Innsbruck, Conradstraße 6, info@planeprint.com
© Design STL files by René Marschall • Layout: marschall designlab, marschall.cc